



**PROPOSED CONSTRUCTION OF LEARNING RESOURCE CENTER, PHASE 2**  
RSU-MAIN CAMPUS



**Construction of Learning Resource Center, Phase 2**  
ROMBLON STATE UNIVERSITY – MAIN CAMPUS



## **TERMS OF REFERENCE**

FOR THE PROCUREMENT AND IMPLEMENTATION OF THE DESIGN AND BUILD SCHEME  
INFRASTRUCTURE PROJECT FOR THE **Construction of Learning Resource Center, Phase 2**  
OF ROMBLON STATE UNIVERSITY-MAIN CAMPUS, LIWANAG, ODIONGAN, ROMBLON.

### **BACKGROUND**



## PROPOSED CONSTRUCTION OF LEARNING RESOURCE CENTER, PHASE 2 RSU-MAIN CAMPUS

The Romblon State University through the approved allocation for **Fund 101 under Fiscal Year 2024 intends to apply the sum of Ten Million Pesos (Php 10,000,000.00)** being the approved budget for the procurement and implementation of the project **Construction of Learning Resource Center, Phase 2** utilizing the Design and Build Scheme with the project duration of **194 calendar days**.

### I. PROJECT DESCRIPTION AND LOCATION

The project will involve the Design and Build Scheme leading to the proposed **Construction of Learning Resource Center, Phase 2** of Romblon State University, Odiongan, Romblon pursuant to the technical specifications indicated in this Terms of Reference, and the RSU System Building Standards and Specifications, enclosed herein.

The building will be located within the Romblon State University – Main Campus compound particularly at the upper part of the campus. (Please refer to the TOR drawings and Site Development Plan)

The project will have an **Approved Budget for the Contract (ABC) of Ten Million Pesos (Php 10,000,000.00)** including all taxes and applicable permits, licenses, and clearances, for the project mentioned above.

### II. CONCEPTUAL DESIGN

#### A. The Construction Project- Design and Build Scheme

##### CONSTRUCTION OF LEARNING RESOURCE CENTER PHASE II

The building design shall conform to the provisions of the National Building Code of the Philippines (PD 1096), Accessibility Law (BP 344), National Structural Code of the Philippines, Electrical Engineering Law (RA 7920), Mechanical Engineering Law (RA 5336), Plumbing Code (RA 1378, 1993-1994 Revisions), Fire Code (RA 9514) and other laws and regulations covering environmental concerns and local ordinances and regulations.

##### **Proposed Building**

The proposed **Construction of Learning Resource Center, Phase 2** shall house the expansion for more multi-functional rooms.

**For the scope of Construction/ Build Scheme:**



## PROPOSED CONSTRUCTION OF LEARNING RESOURCE CENTER, PHASE 2

### RSU-MAIN CAMPUS

The Proposed **Construction of Learning Resource Center, Phase 2** must be structurally finished (*please see indicated plans and Program of Works*). **Building system roughing-ins for the succeeding floor level** must also be provided.

#### Floor Spaces

The **PWD Ramp** shall serve accessibility to elevated ground floor level.

The **Entrance Walk** shall be the primary access to the building.

The **Access Stair** shall supply the accessibility through levels.

The **Office** shall support the diverse activities and needs of a modern workforce for Health and Wellness services.

The **Open Plan Room** shall cater multi-functional activities and services.

The **Comfort Room** will accommodate the immediate needs of the occupant.

The **Power house** will house the maintenance of the building.

#### General and Specific Objective:

- Create a space that encourages collaboration and group study.
- Design flexible spaces with movable furniture to accommodate various group sizes.
- Provide collaborative workstations and technology for group projects.
- Incorporate breakout areas for informal discussions and teamwork.
- Provide a mix of print and digital resources to cater to different learning preferences.
- Integrate a centralized information desk for assistance.
- Integrate multimedia resources, interactive displays, and digital learning platforms.
- Ensure high-speed internet access for research and online learning.
- Allow for easy reconfiguration of spaces to support evolving learning methods.
- Plan for future technology upgrades and changes in curriculum.

## **B. DETAILED DESIGN**



## PROPOSED CONSTRUCTION OF LEARNING RESOURCE CENTER, PHASE 2

RSU-MAIN CAMPUS

Preparation of the following Detailed Design Drawings (see RSU Checklist of Drawings Requirements) based on the approved Design Development Drawings and Design Parameters including any revisions and refinements as approved and required by RSU.

- a. **Detailed Architectural Plans** (refer to Checklist of Drawings Requirements and Design Parameters). *Note: The Architectural Design provided by the procuring entity must not be altered.*
- b. **Detailed Structural Plans** (refer to Checklist of Drawings Requirements and Design Parameters).
- c. **Detailed Electrical Plans** (refer to Checklist of Drawings Requirements and Design Parameters).
- d. **Detailed Auxiliary Plans** (refer to Checklist of Drawings Requirements and Design Parameters).
- e. **Detailed Storm Drain, Sanitary and Plumbing Plans, Grease Trap** (refer to Checklist of Drawings Requirements and Design Parameters). *Sanitary and plumbing plans must integrate with the sewage system to be built as specified in the TOR of Project C, SITE DEVELOPMENT PHASE II (SEWAGE TREATMENT PLANT, PRIMARY SEWER LINES, AND SLOPE PROTECTION).*
- f. **Detailed Mechanical Plans** (refer to Checklist of Drawings Requirements and Design Parameters).
- g. **Structural Computations**, including Soil Boring Test Results and Seismic Analysis and Electrical Design Computations.
- h. **General Notes and Technical Specifications** describing type and quality of materials and equipment to be used, manner of construction and the general conditions under which the project is to be constructed.
- i. **Detailed Bill of Quantities, Cost Estimates** including a summary sheet indicating the unit prices of construction materials, labor rates and equipment rentals.
- j. **Summary of Works**

*Note: The detailed design will be submitted by the winning bidder.*



### III. SELECTION OF DESIGN AND BUILD CONTRACTOR

The procurement and implementation of the project using the “Design and Build” scheme shall be under the provision of RA 9184; specifically; its **ANNEX G**. Bidding process shall be conducted by the Bids and Awards Committee (BAC) to be assisted by the TWG. The Romblon State University Administration shall create the Design and Build Committee (DBC) composed of highly technical personnel in architecture and engineering/construction. The DBC and TWG shall prepare the design brief and performance specifications and parameters, review the detailed engineering design, and assist the BAC in evaluating technical and financial proposals according to the criteria set.

#### **A. Eligibility Requirements**

The eligibility requirements in the Design and Build for infrastructure projects shall comply with the applicable provisions of Section 23-24 of the IRR of RA 9184.

##### a. Eligibility Documents

##### Class “A” Documents

##### *a.1 Legal Documents*

- PhilGEPs Certificate of Registration and Membership as per Section 8.5.2 of the IRR of RA 9184.
- Registration from the Securities and Exchange Commission (SEC), Department of Trade and Industry (DTI) for a sole proprietorship, or Cooperative Development Authority (CDA) for cooperatives;
- Mayor’s permit issued by the city or municipality where the principal of business of the prospective bidders is located;

##### *a.2 Technical Documents*

- Statement of all its ongoing and completed government and private contracts within ten (10) years from the submission of bids
- Single Largest Completed Contract (SLCC)
- Contractor’s Performance Evaluation System (CPES) rating or
- Certificate of Completion
- PCAB licenses and registration for the type and cost of the contract for this project (Small B – License Category C & D) and contractor’s registration certificate from DPWH’

##### *a.3 Financial Document*

- Audited financial statement, stamped “received” by the BIR for the preceding calendar year;
- Tax Clearance
- Net Financial Contracting Capacity (NFCC) computation.



Class "B" Documents

a. Joint Venture Agreement, if applicable

Each joint venture partner shall submit their respective PhilGEPS Certificates of Registration per Section 8.5.2 of RA 9184. The submission of the technical and financial eligibility documents by any joint venture partners constitutes compliance: Provided, that the partner is responsible for submitting the NFCC shall likewise submit the statement of all its ongoing contracts and Audited Financial Statements.

**A. Technical Documents**

Bid Security (in any form)

Project Requirements

a. Preliminary Conceptual Design Plans in accordance with the degree of details specified by the procuring entity.

b. Design and Construction Method

Value engineering analysis of design and construction methods. Prospective bidders shall prepare a value engineering analysis report of their proposed design and construction method to be applied for the PROJECT. Importance shall be made on the following criteria:

- Cost – saving measured on a per square meter average figure.
- Time – saving in design and construction duration was measured using the project's HOPE – approved PERT CPM.

c. List of Design and Construction Personnel / Organizational Chart

- List of Contactor's Personnel with complete qualification and experience data
- List of Contactor's Equipment units, owned, leased, and under purchase agreements, supported by a certification of equipment available from the equipment lessor/vendor for the project's duration

d. Value Engineering analysis of design and construction method

e. Construction Safety and Health Program

f. Omnibus Sworn Statement

**B. Financial Component**

a. Lump sum bid prices, which shall include the detailed engineering cost, in the prescribed Bid Form;

b. Bill of Quantities

c. Detailed estimates including a summary sheet indicating the unit prices of construction materials, labor rates and equipment rentals used in coming up with the bid

d. Cash flow by the quarter and payments schedule.



**PROPOSED CONSTRUCTION OF LEARNING RESOURCE CENTER, PHASE 2**  
RSU-MAIN CAMPUS

**C. Additional Requirements**

- An Authorized Representative must present;
- a. Authorized letter/Special Power of Attorney
  - b. Letter of Intent

**B. Eligibility Criteria**

- a) The eligibility of design and build contractors shall be based on the legal, technical, and financial requirements above – mentioned. As included in the technical specifications, the design and build contractor (as solo or in joint venture/ consortia) should comply with the experience requirements under the IRR of RA 9184. One of the parties (in a joint/consortium) should have at least one similar project, both in design and construction, with at least 50% of the Approved Budget for the Contract (ABC) in the last five (5) years.
- b) If the bidder has no experience designing and building projects on its own, it may enter into joint ventures with design or engineering firm for the design portion of the contract.
- c) It shall observe the relevant provision under Section 23.5.2 of the IRR of RA 9184 on eligibility requirements.

**V. FOR DESIGN PERSONNEL**

For the Pre-Detailed Design and Detailed Design Portion of the contract, the bidder is required to provide the minimum number of professionals as shown below:

**1. Design/Principal Architect**

- a. Licensed Architect
- b. at least five (5) years of experience in the design of residential, academic or institutional facilities, and shall preferable be knowledgeable in applying Green Design Technology in school construction.
- c. Proficient in CADD software

**2. Structural Engineer**

- a. Licensed Structural Engineer
- b. At least five (5) years of experience in structural design and shall be knowledgeable in applying Green Design Technology in school construction.
- c. Proficient in CADD software
- d. Proficient to Structural Design Analysis and software

**3. Electrical Engineer**

- a. Licensed Professional Electrical Engineer (PEE)





## PROPOSED CONSTRUCTION OF LEARNING RESOURCE CENTER, PHASE 2

RSU-MAIN CAMPUS

- b. Preferably at least five (5) years of experience in lighting design power distribution, preferably knowledgeable in emergent, alternative lighting technologies and energy management developments.
    - c. Proficient in CADD software
  4. **Mechanical Engineer**
    - a. Licensed Professional Mechanical Engineer (PME)
    - b. Preferably at least five (5) years of experience in Heating Ventilation and Air Conditioning (HVAC) and fire protection system and preferably knowledgeable in emergent, alternative energy – efficient HVAC technologies
    - c. Proficient in CADD software
  5. **Sanitary Engineer**
    - a. Licensed Sanitary Engineer
    - b. at least five (5) years of experience in the design of building water supply and distribution, plumbing, and preferably knowledgeable in wastewater management/treatment, and emergent, alternative effluent collection and treatment systems, and DENR AO 36 s. 2004 (DAO 92-29 “Hazardous Waste Management”).
    - c. Proficient in CADD software
  6. **Electronics Engineer**
    - a. Licensed Professional Electronics and Communications Engineer (PECE)
    - b. At least five (5) years of experience in design of the network and structured cabling systems, Fire Detection and Alarm System (FDAS), and Closed Circuit Television (CCTV) System.
    - c. Proficient in CADD software
  7. **CADD Operators (2 )**
    - a. with at least 3 years of experience as CADD Operator
    - b. Proficient in CADD software
  8. Other personnel as required for the project

The key professionals listed are required. The Design and Build Contractor may as needed and its own expense, add additional professionals and/or support personnel for the optimal performance of all Architectural and Engineering Design Services, as stipulated in these Terms of Reference for the PROJECT. Prospective bidders shall attach each individual’s resume and PRC license of the (professional) staff and Certificate of Employment.



## **VI. CONSTRUCTION PERSONNEL**

The key professionals and the respective qualification of the CONSTRUCTION PERSONNEL, shall be as follows:

### **A. Project Manager**

- a. Licensed architect or engineer
- b. At least three (3) years relevant experience on similar and comparable projects in different locations
- c. Proven record of managerial capability through the directing/managing of major civil engineering works, including projects of a similar magnitude.

### **B. Project Engineer/ Architect**

- a. Licensed architect or engineer
- b. At least three (3) years relevant experience on similar and comparable projects
- c. Knowledgeable in the application of rapid construction technologies.

### **C. Materials Engineer**

- a. Duly accredited Materials Engineer
- b. At least three (3) years relevant experience on similar and comparable projects
- c. Knowledgeable in the application of rapid construction technologies.

### **D. Electrical Engineer**

- a. Registered Electrical Engineer
- b. At least three (3) years relevant experience in lighting design, power distribution
- c. Preferably knowledgeable in development in emergent efficient lighting technologies and energy management.

### **E. Mechanical Engineer**

- a. Duly – licensed Mechanical Engineer
- b. At least three (3) years relevant experience in similar and comparable projects in installing HVAC and fire protection
- c. preferably knowledgeable in applying Green Building technologies.

### **F. Sanitary Engineer/ Licensed Master Plumber**

- a. Duly – licensed Sanitary Engineer/ Licensed Master Plumber
- b. At least three (3) years relevant experience in similar and comparable projects in installing water supply, distribution, and plumbing.



**G. Electronics and Communications Engineer**

- a. Licensed Electronics and Communications Engineer
- b. At least three (3) years relevant experience installing network cabling systems and structured cabling, FDAS, and CCTV systems.

**H. Foreman**

- a. at least ten (10) years of experience in similar and comparable projects
- b. preferably knowledgeable in applying Green Building technologies.

**I. Safety Officer II**

- a. Accredited safety practitioner by the Department of Labor and Employment (DOLE)
- b. Has undergone the prescribed 40-hour Construction Safety and Health Training (COSH).
- c. at least three (3) years of experience of Safety Officer (COSH).

**J. First Aider**

- a. Must have completed the (4) four-day Occupational First Aid Training with BLS CPR AED in compliance to DOLE Requirements DO No. 198-18 and Do No. 235-22
- b. at least three (3) years of experience

**K. Welder**

- c. at least five (5) years of experience in similar and comparable projects and preferably knowledgeable in applying Green Building technologies.
- d. Certified TESDA NCII (SMAW or TIG Welder)

The above key personnel listed are required. The DESIGN & BUILD CONTRACTOR may, as needed and at its own expense, add additional professionals and/or support personnel for the optimal performance of all Construction Services, as stipulated in these Terms of Reference, for the Project. Prospective bidders shall attach everyone's resume and PRC license of the (professional) staff, proof of qualifications, and related documents as necessary.

*Note: Please seek signed approval to the Procuring Entity for changes in key personnel.*

**VII. PRELIMINARY DESIGN AND CONSTRUCTION STUDIES**

The bidder shall represent that:

1. He has thoroughly review and understand all the bid documents, and his bid will be in accordance there with.



**PROPOSED CONSTRUCTION OF LEARNING RESOURCE CENTER, PHASE 2**  
RSU-MAIN CAMPUS

2. His bid is based upon the conditions and requirements of the bid documents without exception.
3. He has visited and inspected the Site of Works and its surroundings as certified by the DBC Chairman. Satisfied himself as to all matters on the project, including the following: location and the nature of the work; climatic conditions; the nature and condition of the terrain; geological condition at the sites; transportation and communication facilities; the requirement and the availability of materials, labor, water, electric power and roads; the location and extent of aggregate sources, and other factors that may affect the cost, duration, and execution of the work; that he has determined the general characteristics of the project and the conditions indicated above. *(Please Refer to **ANNEX D: PRELIMINARY SURVEY AND MAPPING** and **ANNEX F: UTILITY LOCATIONS**).*
4. Utilize the existing geotechnical/soil investigation report as the basis for the computation of structural analysis of the building. *(Please Refer to **ANNEX E: PRELIMINARY INVESTIGATION – Foundation Design and Recommendations**)*
5. He familiarized himself with all the conditions that may affect the contract work's implementation of estimated available and needed facilities for the project. Where required, design components shall be designed in coordination with the agencies concerned (e.g., coordinate with the electric company for power lines and the concerned company/agency for water and sewage lines).
6. He is aware that Romblon State University shall not assume any responsibility regarding erroneous interpretations from any data furnished by the University.
7. He familiarized himself with all laws, decrees, and regulations of the Philippines, RSU, and the local government where the campus is located, which affect or apply to the operations and activities of the Designer.
8. He is aware that the design period of the project shall be the first fourteen (14) calendar days reckoned from the date of the NOTICED TO PROCEED, excluding the days spent for the approval of the detailed architectural and engineering design, and the design and construction period shall be **194 calendar days**.
9. No bidding and award of Design and Building contracts shall be made unless the required preliminary design and construction studies have been sufficiently carried out and duly approved by the Head of the Procuring Entity that shall include, among others, the following:



## PROPOSED CONSTRUCTION OF LEARNING RESOURCE CENTER, PHASE 2

RSU-MAIN CAMPUS

- **Project Description** – included in ITEM II: Project Description and Location
- **Conceptual Design** – attached in ANNEX A
- **Performance Specifications and Parameters** – attached in ANNEX C
- **Preliminary Survey and Mapping** – Attached in ANNEX D
- **Preliminary Investigations** – Attached in ANNEX E
- **Utility Location** – Attached in ANNEX F
- **Approved Budget for the Contact** – included in ITEM XV
- **Proposed Design and Construction Schedule** -Attached in ANNEX G
- **Minimum requirements for a Construction Safety and Health Program for the project**  
– Refer to ANNEX F
- **Tender/Bidding Documents**, including Instructions to Bidders and Condition of Contract

10. The Contractor shall submit a detailed program of works within fourteen (14) calendar days after the issuance of the Notice to proceed for approval by the Procuring entity that shall include, among others:

- The order in which it intends to carry out the work including anticipated timing for each stage of design /detailed engineering and construction
- Periods for review of specific outputs and any other submissions and approvals
- The sequence of timing for inspection and test;
- General description of the design and construction methods to be adopted;
- Number and names of personnel to be assigned for each stage of the work;
- List of equipment required on – site for each stage of the work; and
- The descriptions of the Quality Control System to be used for the proposed project.

The above data are for reference only. The procuring entity does not guarantee that these data are fully correct, up to date, and applicable to the project at hand. The contractor is responsible for the accuracy and applicability of all data, including the above, that it will use in its design and build proposal and services.

The acquisition of right-of-way and the conduct of eminent domain proceedings shall still be the responsibility of the procuring entity, which shall include a preliminary budget for this purpose.

### VIII. DETAILED ENGINEERING REQUIREMENT



## PROPOSED CONSTRUCTION OF LEARNING RESOURCE CENTER, PHASE 2

RSU-MAIN CAMPUS

- Upon awarding the design and build, the winning bidder shall be responsible for preparing and submitting all necessary detailed engineering investigations, surveys, and method according to the Term of Reference.
- The procuring entity shall include all the necessary schedules concerning the detailed engineering design's submission, confirmation, and approval. It shall consist of the details of the construction methods in the contract documents.
- The procuring entity shall review, order rectification, and approve or disapprove for implementation only – the submitted plans within these schedules. All instructions for rectification shall be in writing, stating the reasons for such rectification. The design and build contractor shall be solely responsible for the integrity of the detailed engineering design and the performance of the structure irrespective of the approval/confirmation by the procuring entity.

### IX. SCOPE OF WORKS AND PROJECT IMPLEMENTATION

#### A. DESIGN

- a. From the approved schematic design document, the contractor must prepare the following: prepare the complete construction drawings and detailed technical specifications; detailed engineering estimates and the bill of quantities; setting forth in detail the work required for the architectural, structural, civil, landscape architecture, electrical, plumbing/sanitary, mechanical and other service – connected equipment; utilities; site planning aspects and related works; electronic and communications and the site development plan of the PROJECT's immediate environs.
- b. Prepare layouts, specifications, and estimates of all furniture and equipment required for the fit out of the building.
- c. Prepare the scope of work for construction based on the prepared bill of quantities and cost estimate while fitting the approved budget.
- d. Provide value engineering analysis on all prepared construction documents.
- e. Prepare Material specifications to be used in the PROJECT
- f. Soil Testing (necessary for Structural Design Analysis)

#### B. PRE – CONSTRUCTION

- a. Secure all necessary building permits prior to construction. It shall include all incident fees in the cost estimate of the building.
- b. Prepares PERT – CPM for the construction phase.
- c. Provides all other necessary documents that D&B Committee shall require.
- d. Groundbreaking Ceremony and Workshop Conference
- e. Printing of COA Tarpaulin



### **C. CONSTRUCTION PHASE**

- a. Implements all works indicated in the approved construction drawing and document. All revisions and deviations from the approved plans, significantly impacting the project's overall cost, shall be subject to approval.
- b. In response to the results of soil and materials testing, the contractor must provide soil filling, grading and other soil protection measures of the building and other elements of the site,
- c. Constructs the building, complete with utilities and finishes, resulting in operable and usable structures.
- d. The contractor must provide protection or relocation of existing trees indigenous to the area and properly remove and replace all introduced trees and vegetation affected by the construction.
- e. The contractor must provide layouts, piping, conduits, manhole, boxes and other lines for utilities, including tapping to existing utility lines. Facilitate the connection of all utilities (power, water, sewer, structured cabling, and telephone) with their corresponding utility companies.
- f. The contractor must install fire protection system and fixtures, fire extinguishers, emergency lights, and lighted fire exit signs.
- g. The contractor must prepare shop drawing for approval.
- h. Coordinates with the D & B Committee regarding the scheduling of delivery and installation of all owner-furnished materials and equipment during construction.
- i. Conducts all necessary tests (required by the D & B Committee) and issues results reports.
- j. The contractor must submit materials, products, specifications, and sample for approval using material submittal form as the build and design committee requires.
- k. Rectifies punch – listing works to be inspected and issued by the D & B Committee and/or the End- user.
- l. Complies with DOLE – OSH requirements and submits periodic reports concerning occupational safety and health. (Please Refer to ANNEX F: MINIMUM REQUIREMENTS FOR A CONSTRUCTION SAFETY AND HEALTH PROGRAM)
- m. Provides all other necessary documents that the D & B Committee shall require.
- n. The contractor must submit Bill Certificates of all reinforcement steel bars to be used and Concrete Cylindrical Test Reports of all concrete structural components.

### **D. POST- CONSTRUCTION PHASE**

- a. Prepares as-built plans
- b. Turn overs of all manuals, certificates, and warranties of installed items.
- c. Secures building certificate of occupancies and fire safety inspection certificate
- d. Site Clearing – upon completion of the works, immediately clear the site and remove all plans, supplies, materials, rubbish, and temporary facilities.



- e. Turn overs of all material purchases catalogs.

#### **F. DEFECTS AND LIABILITY**

- a. These design and build projects shall have a minimum Defects Liability Period of one (1) year after contract completion or as provided for in the contract documents. This statement is without prejudice to the liabilities imposed upon the engineer/architect who drew up the plans specifications for buildings sanctioned under *Section 1723 of the New Civil Code of the Philippines*.
- b. In accordance with *Section 62.2.3.2 of the IRR (RA 9184)*, the contractor shall be held liable for design, structural defects, and/or failure of the completed projects within the warranty period of 15 years (permanent structures/buildings)

#### **X. OVERALL PROJECT TIME SCHEDULE**

The DESIGN & BUILD CONTRACTOR shall comply the most reasonable time schedule for the completion of the project. It is expected that this period will **not exceed 224 calendar days** from the date of the issuance of the Notice to Proceed (NTP): **Fourteen (14) calendar days for the Design Phase and Two Hundred Ten (210) calendar days for the Construction Phase.**

***\*\*\*Construction day 1 will commence prior to the approval of the plans and design by implementing office.\*\*\****

#### **XI. THE IMPLEMENTING AGENCY'S GENERAL RESPONSIBILITY**

The implementing agency for the project is the University President with final approval for all decisions and actions through the Design and Build Committee. The D&B Committee shall:

- a. Prepare the design brief for the project in accordance with the conditions and design criteria enumerated in the Terms of Reference.
- b. Coordinate with DESIGN & BUILD CONTRACTOR, and the University President with regards to the design and implementation of the project.
- c. Assist in the coordination of the DESIGN & BUILD CONTRACTOR with various utility agencies during the detailed design and implementation phases of the project.
- d. Conduct regular coordination meetings between the DESIGN & BUILD CONTRACTOR and Romblon State University to facilitate the implementation of the project.

#### **XII. THE DESIGN & BUILD CONTRACTOR'S GENERAL RESPONSIBILITY**





## PROPOSED CONSTRUCTION OF LEARNING RESOURCE CENTER, PHASE 2

RSU-MAIN CAMPUS

- a. The DESIGN & BUILD CONTRACTOR shall certify that he has, at his own expense, inspected and examined the proposed project site, its surroundings and existing infrastructure and facilities related to the execution of the work and has obtained all the pieces of information that are considered necessary for the proper execution of the work covered under these Terms of Reference.
- b. The DESIGN & BUILD CONTRACTOR shall ensure that all works at the stages of design, construction, restoration of affected areas, and testing and commissioning shall be carried out efficiently and effectively.
- c. The DESIGN & BUILD CONTRACTOR shall provide Romblon State University with complete reports such as technical analysis, maps and details regarding the existing conditions and proposed improvements within the site.
- d. The DESIGN & BUILD CONTRACTOR shall consider the academic calendar and critical dates and occasions within Romblon State University, in order to align his work schedule with the academic calendar of the school to avoid unnecessary disruption of school activities due to construction activities such as closure of water and power supply and non-usage of the existing roads.
- e. The DESIGN & BUILD CONTRACTOR shall inform Romblon State University of critical events during construction, especially when such events can potentially disrupt school activities.
- f. The DESIGN & BUILD CONTRACTOR shall be PCAB accredited and shall have a Construction Safety and Health Program approved by DOLE and designed specifically for the proposed **Construction of Learning Resource Center, Phase 2.**
- g. The DESIGN & BUILD CONTRACTOR will be held accountable for accidents that might occur during the execution of the project. The DESIGN & BUILD CONTRACTOR is required to install warning signs and barriers for the safety of the general public and the avoidance of any accidents and provide appropriate and approved type personal protective equipment for their construction personnel.
- h. The DESIGN & BUILD CONTRACTOR shall be professionally liable for the design and shall submit a signed and sealed copy of the approved construction documents to form part of the Contract Documents.
- i. **Only the plans approved by the Head of Procuring Entity (HOPE) shall be signed and sealed by the DESIGN & BUILD CONTRACTOR,** and thereafter shall be the plans used for construction.
- j. All works designed and constructed should be guaranteed to seamlessly fit into the overall system general design standards of Romblon State University.

### XIII. PROJECTED SUBMITTALS DURING THE PROJECT

The following submittals and accomplished documents shall be duly completed and turned over by the DESIGN & BUILD CONTRACTOR for the project:



**PROPOSED CONSTRUCTION OF LEARNING RESOURCE CENTER, PHASE 2**  
RSU-MAIN CAMPUS

**A. FOR THE DESIGN PHASE**

Detailed Design Phase including review and approval by the Design and Build Committee (DBC), which should be completed within the first 30 Calendar Days from receipt of Notice to proceed which shall include the submission of the following:

- a) Construction plans (signed and sealed) that include Architectural, Civil, Structural, Electrical, Structural Cabling, Mechanical, Fire Protection and Plumbing programs **(9 sets hard copy – a3, 1 set hard copy - a1 and soft copy,)** – *please refer ANNEX B: CHECKLIST OF DRAWING REQUIREMENTS*
- Detailed Architectural Plans (refer to ANNEX – B Checklist of Drawing Requirements & ANNEX C: Performance Specification and Parameters)
  - Detailed Structural Plans (refer to ANNEX – B Checklist of Drawing Requirements & ANNEX C: Performance Specification and Parameters)
  - Detailed Electrical Plans (refer to ANNEX – B Checklist of Drawing Requirements & ANNEX C: Performance Specification and Parameters)
  - Detailed Storm Drain, Sanitary, and Plumbing Plans (refer to ANNEX – B Checklist of Drawing Requirements & ANNEX C: Performance Specification and Parameters)
  - Detailed Mechanical Plans (refer to ANNEX – B Checklist of Drawing Requirements & ANNEX C: Performance Specification and Parameters)
  - Detailed Material Specification
  - Structural Design Analysis (Signed and Sealed by a Licensed Civil Engineer)
- b) Structural Computations, including Soil Boring Test Result and Seismic Analysis and Electrical Design Computation.
- c) General Notes and Technical Specifications describe the type and quality of materials and equipment used, the manner of construction, and the general conditions under which the project is to be constructed. **(9 sets hard copy – a3, 1 set hard copy - a1 and soft copy,)**
- d) Detailed Bill of Quantities, Cost Estimates including a summary sheet indicating the unit prices of construction materials, labor rates, and equipment rentals **(9 sets hard and soft copy)**
- Site survey, topographic survey, survey of existing trees, and all other pertinent data related to the conditions of the project site.
  - Documents required for securing the Building Permit
  - Drawings and reports that the D & B Committee may require periodic updates concerning the status of the design phase.



## PROPOSED CONSTRUCTION OF LEARNING RESOURCE CENTER, PHASE 2

### RSU-MAIN CAMPUS

- Summary of Works.

*Note: The Prospective bidder must present their Design based on the concept of the Procuring Entity. The Design of the Procuring Entity is for reference purposes only. **Non – compliance with all the requirements indicated in this Terms of Reference will be subject to the failure or disqualification of the Prospective bidder.***

#### **B. FOR THE CONSTRUCTION PHASE (9 copies each)**

- All necessary permits (including fees)
- Shop drawings (hard and soft copy)
- PERT – CPM
- Test results
- Guarantees, warranties, and other certificates
- Fire and Life Safety Assessment Report 2 and 3 (FALAR 2 and 3)

#### **C. FOR THE POST – CONSTRUCTION PHASE (9 copies each)**

- As built plans (hard and soft copy) signed and sealed
- Certificate of Occupancy
- Fire Safety Inspection Certificate
- All other necessary documents to be required by D & B Committee

***All drawing included in the contract documents should be drawn using CAD software and plotted on 20"x30" sheets and A3 size. All other textual submittals shall be printed, and ring bound on A4 sized sheets.***

#### **XIV. CODES AND STANDARDS**

The project shall be designed, engineered, installed, tested, commissioned and handed over in conformity with the Building and Design Standards of the PSHS System and with the latest editions of the National Building Code of the Philippines, the National Structural Code of the Philippines, the Philippine Electrical Code, Philippine Mechanical Code, the National Plumbing Code of the Philippines, National Fire Code of the Philippines and other relevant codes and standards.

#### **XV. INSTALLATION AND WORKMANSHIP**

The Design and Build Contractor personnel should be specialists highly skilled in their respective trades, performing all labor according to first – class standards. A full – time Project Engineer/Architect and Construction Safety Engineer shall be assigned by the Design & Build Contractor at the job site during the project's construction.



## PROPOSED CONSTRUCTION OF LEARNING RESOURCE CENTER, PHASE 2

RSU-MAIN CAMPUS

Tapping for utilities (e.g., power supply, water supply, and sewage drainage) shall be coordinated with their respective utilities/service provider. Also, all works involved, including access to utility tapping points, excavation, removal of obstructions, concrete breaking, backfilling, and restoration of affected areas, shall be coordinated and included in the project's scope of work and cost.

### XVI. MATERIALS

All materials and equipment shall be standard products of manufacturers engaged in producing such materials and equipment and shall be the manufacturer's latest standard design. The materials shall be delivered and turn-over in good condition and complete.

All materials shall include conformance with the latest standards and with inspection and approval from the D & B Committee. The contractor shall submit a sample of materials and its catalog for approval.

### XVII. MODE OF PAYMENT

- A. The Romblon State University shall pay the winning DESIGN & BUILD CONTRACTOR progress payments based on billings for actual works accomplished, as certified by D & B Committee of the RSU System. In no case shall progress billing be made more than once every thirty (30) calendar days. Materials or equipment delivered on the site but not completely put in place or used in the project shall not be included for payment.
- B. Progress payments are subject to retention of ten percent (10%) referred to as the "retention money." Such retention shall be based on the total amount due to the contractor prior to any deduction and shall be retained from every progress payment until fifty percent (50%) of the value of works, as determined by the procuring entity, are completed. If, after fifty percent (50%) completion, the work is satisfactorily done and on schedule, no additional retention shall be made; otherwise, the ten percent (10%) retention shall be imposed.
- C. The DESIGN & BUILD CONTRACTOR may request in writing which must be submitted to form part of the Contract Documents, for an advanced payment equivalent to fifteen percent (15%) of the total Contract Price. The advance payment shall be made once the DESIGN & BUILD CONTRACTOR issues its irrevocable standby letter of credit from a reputable bank acceptable to the RSU System, or GSIS Surety Bond of equivalent value, within fifteen (15) days from the signing of the Contract Agreement to cover said advanced payment.

First Payment/Billing shall have an accomplishment of at least 20% of the construction phase.



## **PROPOSED CONSTRUCTION OF LEARNING RESOURCE CENTER, PHASE 2**

### RSU-MAIN CAMPUS

The following documents must be submitted to the Design and Build Committee before processing of payments to the DESIGN & BUILD CONTRACTOR can be made:

- Progress Billing
- Detailed Statement of Work Accomplished (SWA)
- Request for payment by the DESIGN & BUILD CONTRACTOR
- Pictures/photographs of original site conditions (for First Billing only)
- Pictures/photographs of work accomplished.
- Payment of utilities (power and water consumption)
- DESIGN & BUILD CONTRACTOR's affidavit (if accomplishment is more than 60%)
- Mill certificate and test report on cylindrical concrete sample.

*Note: Please refer to **ANNEX "E"** OF THE 2016 IMPLEMENTING RULES AND REGULATIONS (IRR) OF REPUBLIC ACT (RA) NO. 9184 AND THE PHILIPPINE BIDDING DOCUMENTS FOR INFRASTRUCTURE PROJECTS.*

#### **XVIII. APPROVED BUDGET COST**

The total budget for the project involving the Design and Build Scheme for the proposed **Construction of Learning Resource Center, Phase 2 is Ten Million Pesos (Php 10,000,000.00).**



**PROPOSED CONSTRUCTION OF LEARNING RESOURCE CENTER, PHASE 2**  
RSU-MAIN CAMPUS

**Prepared by:**

**Mr. Zaldy F. Montoya**  
Chairman, Design and Build Committee

**Ms. Hannah Faith P. Morta**  
Member, Design and Build Committee

**Engr. Noel M. Tianga, Jr.**  
Member, Design and Build Committee

**Engr. Alvin/John D. Brecia**  
Member, Design and Build Committee

**Engr. Bliven U. Garcia**  
Member, Design and Build Committee

**Learning Resource Center**  
End User

**Noted by:**

**Atty. Glenn Niño M. Sartillo**  
Chairman, Bids and Awards Committee

**Approved by:**

**Merian P. Catajay-Mani, Ed.D, CESE**  
University President



## **ANNEX B - CHECKLIST OF DRAWINGS REQUIREMENTS AND DESIGN PARAMETERS**



## **A. ARCHITECTURAL DESIGN PARAMETERS**

### **I. Codes and Standards**

The Architectural Works shall be in accordance with the following Philippine laws, Codes and Standards.

- **Laws and Codes:**
  1. National Building Code of the Philippines and its Latest and Amended IRR
  2. RA 9266 or Architectural Law and its Latest and Amended IRR
  3. BP 344 or Accessibility Law and its Latest and amended IRR
  4. AO 35,s. 1994 or, AO Pertaining to the Control of Radiation Hazards
  5. RA 9514 New Fire Code of the Philippines
  6. Existing Local Codes and Ordinances.
  7. And other Laws that applies to the projects
- **Standards:**
  1. Bureau of Product Standards (BPS)
  2. Underwriters Laboratory (UL)

### **II. Proposal should include the following:**

- Perspective, Site Development Plan, Vicinity Map/Location Plan
- Floor Plans (scale 1:100 minimum) including proposed furniture layout
- Roof Plan/s showing downspouts (scale 1:100 minimum), including detail of gutter downspout, etc.
- Reflected ceiling plan/s (scale 1:100 minimum), including details
- Details of Stairs, fire escapes/exits, accessible ramps etc., in the forms of plans evaluation/section
- Details of Toilets (1:50m) including accessible toilets in the form of plans, evaluation/section
- Details of specialized design features (scale 1:50m) such as partitions cabinets, etc. and accessible design features (if applicable)
- Detail of typical bay section from ground to roof (scale 1:50m)





## PROPOSED CONSTRUCTION OF LEARNING RESOURCE CENTER, PHASE 2

RSU-MAIN CAMPUS

- Details of rooms (1:50m) in the form from floor to roof (scale 1:50m)
- Schedule of doors, gates emergency exits, etc., (scale 1:50m), including specifications for materials and hardware
- Schedule of windows (scale 1:50m) including specifications for materials and hardware
- Schedule of finishes for interior and exterior floors, walls ceilings
- Architectural Interior Design Technical Specifications
- Architectural Interior Design Scope of Works
- Architectural Interior Design Bill of Quantities
- Cost Analysis

### B. STRUCTURAL/CIVIL WORKS DESIGN PARAMETERS

#### I. Codes and Standards

The Civil/Structural Design shall be in accordance with the following Philippine laws, Codes and Standards.

- Codes
  1. National Structural Code the Philippines (NSCP) 2015
  2. National Building Code of the Philippines and its Latest and Amended IRR
  3. Civil Engineering Law R.A. 544
  4. RA 9514 New Fire Code of the Philippines
  5. Accessibility Law
  6. Local Codes and Ordinances
  7. And other Laws that applies to the projects
- Standards
  1. Bureau of Product Standards (BPS)
  2. Philippine National Standards (PNS)
  3. DPWH Blue Book
  4. American Concrete Institute (ACI)
  5. American Society for Testing Materials (ASTM)
  6. American Welding Society (AWS)
  7. American Institute of Steel Construction (AISC)

#### II. Proposal should include the following:



- General Notes and construction Standards
- Site Development Plan
- Foundation Plan/s (scale 1:100m minimum)
- Floor Framing Plan/s (scale 1:100m minimum)
- Roof Framing Plan/s (scale 1:100m minimum)
- Schedule and Detail of Footings and Columns
- Schedule and Detail of Beams and Floor Slabs
- Details of Connections
- Details of Trusses
- Details of Stairs, Ramps, Fire Exits
- Other Spot Details
- Structural Analysis and Design (for 2-storey building and higher)
- Seismic Analysis
- Geotechnical Analysis
- Structural and technical specifications
- Structural Scope of Works
- Structural Bill of Quantities
- Cost Analysis

## **C. SANITARY/PLUMBING DESIGN**

### **I. Codes and Standards**

The Sanitary/Plumbing Design shall be in accordance with the following Philippine laws, Codes and Standards.

- Codes:
  1. National Building Code of the Philippines and its Latest and Amended IRR
  2. RA 9514 New Fire Code of the Philippines
  3. National Plumbing Code of the Philippines (NPCP)
  4. Sanitation Code of the Philippines
  5. Existing Local Codes and Ordinances
  6. And other Laws that applies to the projects
- Standards:
  1. Bureau of Product Standards (BPS)
  2. Philippine National Standards for Drinking-Water
  3. Underwriters Laboratory (UL)



**PROPOSED CONSTRUCTION OF LEARNING RESOURCE CENTER, PHASE 2**  
RSU-MAIN CAMPUS

4. DOH National/Laboratory (NRL)
5. DOH Health Care Waste Management Manual
6. National Water Resources Board (NWRB)
7. National Plumbers Association of the Philippines (NAMPA)
8. Philippine Society of Sanitary Engineers, Inc., (PSSE)

**II. Proposal should include the following:**

- General Notes and Legends
- Location and Site Plan
- Storm Drainage Layout (scale 1:100m minimum) including actual length of tapping line to Main Drainage line
- Water line Layout (scale 1:100m minimum) including actual length of tapping line from main water source when applicable
- Sewer line Layout (scale 1:100m minimum) including actual length of tapping line to septic tank or existing sewer line
- Isometric Layout, showing waterline, sewer line and drainage line
- Details Water Tank, Flow Diagram (scale 1:50m)
- Details of connections catch basins, downspouts, etc.
- Details of Septic Tank/Sewer Treatment Plant
- Design Analysis
- Sanitary Technical Specifications
- Sanitary Scope of Works
- Sanitary Bill of Quantities
- Cost Analysis

**D. MECHANICAL WORKS DESIGN**

**I. Codes and Standards**

The Mechanical Design shall be in accordance with the following Philippine laws, Codes and Standards.

- Codes:
  1. National Building Code of the Philippines and its Latest and Amended IRR
  2. RA 9514 New Fire Code of the Philippines
  3. Mechanical Engineering Code of the Philippines (ME Code)
  4. Existing Local Government Codes and Ordinances



5. And other Laws that applies to the projects
- Standards:
    1. Bureau of Product Standards (BPS)
    2. Philippine National Standards (PNS)
    3. Underwriters Laboratory (UL) and Factory Mutual (FM)
    4. International Electro-Technical Commission (IEC) 1988
    5. National Fire Protection Association (NFPA)
    6. National Fire Protection Association (NFPA) 99 Standard for Health Care Facilities.
    7. American Society of Heating, Refrigeration and Air Conditioning Engineers (ASHRAE).
    8. Center for Disease Control and Prevention (CDC) Manual.

**II. Proposal should include the following:**

- General Notes and Legends, Site Development Plan, Location Plans
- Floor Plans/Isometric Drawings (scale 1:100n minimum) showing Ventilation and Air Conditioning Systems and other installations
- Floor Plan/s Isometric Drawings (scale 1:100m minimum) of Air Conditioning Systems and details
- Floor Plans/Isometric Drawings (scale 1:100m minimum) of Fire Suppression Systems, fire sprinkler system, wet standpipe, dry standpipe and other installation
- Details Water Tank, Flow Diagram (scale 1:50m) (Should be in Plumbing)
- Details of Firewater Supply System (scale 1:50m) (Confirm if water or CO2 sprinkling system)
- Technical Specification
- Mechanical Scope of Works
- Mechanical Bill of Quantities
- Cost Analysis

**E. ELECTRICAL & AUXILLARY DESIGN PARAMETERS**



## **I. Codes and Standards**

The Electrical System Design Parameters shall be in accordance with the following Philippine laws, Codes and Standards.

- Codes:
  1. Philippine Electrical Code
  2. National Electrical Code
  3. RA 9514 New Fire Code of the Philippines
  4. National Building Code of the Philippines and its Latest and Amended IRR
  5. Existing Local Codes and Ordinances
  6. And other Laws that applies to the projects
  
- Standards:
  1. Bureau of Product Standards (BPS)
  2. Underwriters Laboratory (UL)
  3. National Fire Protection Association
  4. International Electro Technical Commission (IEC)
  5. Illumination Engineering Society (IES)
  6. National Electrical Manufacturer's Association (NEMA)

## **II. Proposal should include the following:**

- General Notes and Legends
- Location and Site Plan
- Lighting Layout (scale 1:100m minimum) including details
- Power Layout (scale 1:100m minimum) including details
- Auxiliary System Layout (scale 1:100m minimum) including details (Telephone System with Intercom, WAN and LAN System, Fire Alarm System, Audio, Video and others)
- Schedule and Details of Loads
- Riser Diagram
- Other Detail
- Electrical Computation
- Design Analysis
- Electrical Technical Specifications
- Electrical Scope of Works



**PROPOSED CONSTRUCTION OF LEARNING RESOURCE CENTER, PHASE 2**  
RSU-MAIN CAMPUS

- Electrical Bill of Quantities
- Cost Analysis

**F. FIRE PROTECTION DESIGN PARAMETERS**

The Fire Protection System Design Parameters shall be in accordance with the following Philippine laws, Codes and Standards.

**III. Proposal should include the following:**

- General Notes and Legends
- Location and Site Plan
- Fire Protection Layout (scale 1:100m minimum) including details



## **ANNEX C – PERFORMANCE AND SPECIFICATIONS PARAMETERS**



## A. CONSTRUCTION REQUIREMENTS

### ***General Requirements***

Buildings proposed for construction shall comply with all the regulations and specifications herein, governing quality, characteristics and properties of materials, methods of design and construction, type of occupancy, and classification.

All other matters relative to the structural design of all buildings and other structures not provided shall conform with the provisions of the National Structural Code of Buildings, as adopted and promulgated by the Board of Civil Engineering pursuant to RA 544, as amended, otherwise known as the “Civil Engineering Law”.

### ***Construction Type***

**Type IV** – The building shall be steel, iron, concrete, or masonry construction. The walls, ceilings, and permanent partitions shall be incombustible **2-fire – resistive construction**. *Except* for that, permanent non-bearing partitions of one-hour fire-resistive construction may use fire-retardant-treated wood within the framing assembly.

### **Category of Construction**

Category 1 Essential Facilities – Public School Building.

### ***Changes in Types***

No revision in the type of construction shall be made. This revision would place the building in a different sub-type or type of construction unless such structure is made to comply with such sub-type of construction requirements. Except for that, the Building Official approves the changes upon showing that the new or proposed construction is less hazardous, based on the life and fire risk than the existing construction.

### **Construction Method**

1. Technical personnel assigned to the project should be knowledgeable and responsible enough.
2. Shall establish the Project Supervision and hierarchy first.
3. Shall do Construction methods for each work indicated in the design.
4. The material shall pass the required specification.
5. Should do quality control on all work items as construction progresses.
6. Shall use Proper equipment for each work item.





7. Materials quantity shall be well provided. Scarcity of one material can be the basis of delay for each work that may affect other items' schedules.

### **Quality Control**

Quality control works consist of all work elements carried out by the manager or those in his organization, which contribute to the quality of the organization's output. Quality Control procedures include:

**Selection of Materials.** Information regarding the source of the materials to be incorporated into the work may be represented by the following:

- Raw materials such as soil, sand, and bank or river gravel (with little or no processing)
- Materials that are processed without changing their properties, such as washed/manufactured sand, crushed rock, gravel, etc.
- Combination of materials that may be partly or totally manufactured (e.g., Bituminous and Portland cement concrete)

**Handling and Storage of Materials.** Materials should be placed in a safe place protected from contamination or the action of water to avoid damages. Protection of materials is significant and should be accessible to the project site.

**Sampling Testing of Materials.** Materials that require proper testing sample shall be provided and tested. Testing sampling shall be witnessed and approved by the implementing office. These are indicated in American association of State Highway and Transportation (AASHTO) and American Society for Testing and Materials (ASTM). Quality control also required proper testing, construction method, and workmanship.

### **Contractor's Materials Engineer**

Department Order 11 Series of 2017 requires the Contractor to provide minimum testing equipment in the technical component of the bid. The Materials Engineer must secure this, and his Contractor shall provide it.

Department Order 13, Series of 1987 states that the Material Engineer shall be in-charge in sampling the testing of the materials. He shall accompany him in the actual testing by the Government Materials Engineer or a representative of the implementing office who will witness their assurance.



Department Order 213, Series of 2004 states that the materials shall be tested prior to incorporating the works. The materials engineer shall ensure that the materials to be used shall conform to the specifications and requirements of DPWH.

#### **Primary Duties and Responsibilities of Contractor's Materials Engineer**

1. Responsible for the sampling, testing inspection, and submission of quality control report data.
2. Prepare design mixes for concrete.
3. Accomplish, update, and keep the test report records such as materials logbook.
4. Ensure that the samples are properly cured according to standard procedures.
5. Ensure that the field tests are adequately equipped so that the process of work will not be impeded by laboratory testing, and non-performance of the test should not be the cause of delay in project implementation.
6. Recommend whether the quality of materials used in the project is acceptable and passes the requirement of DPWH standard Specifications (Volumes 2 and 3).
7. Recommended corrective and remedial measures to improve the quality and correct the unsatisfactory condition of materials.
8. Recommended corrective measures to improve the quality of completed works.
9. Recommend the acceptance of the completed works as well as advise the Project Engineer (Government or Contractor's side)

#### ***Fire – Resistive Requirements in Construction***

All materials of construction and assemblies or combinations therefore shall be classified according to their fire-retardant or flame-spread ratings as determined by generally accepted testing methods.

Fire – resistive time rating is the length of time a material can withstand burning: one hour; two – hours, three hours, four hours, etc.

All pertinent materials to be used shall be supported by a fire testing certificate.



## Construction of Learning Resource Center, Phase 2

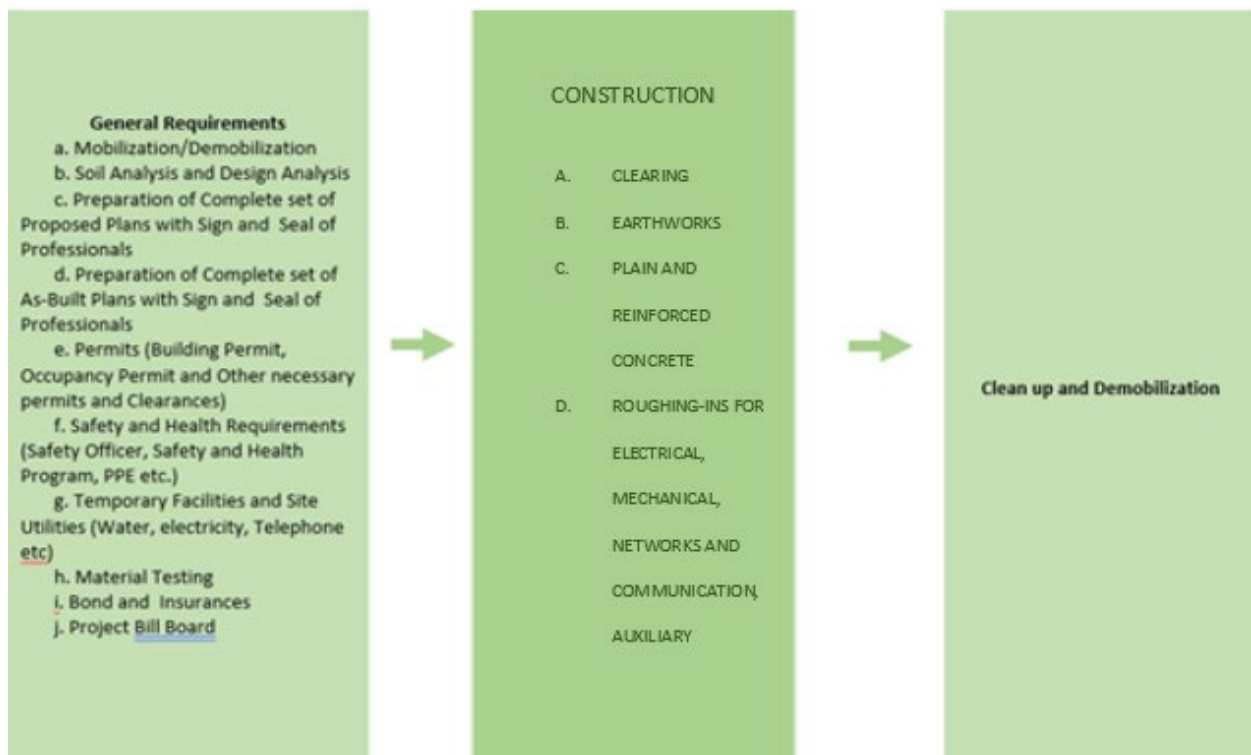

### Work Breakdown Structure

#### Part 1 General Requirements

1. **Mobilization** (including Bonds, Permits, (Fine) & Clearances. Mobilization shall include all activities and costs for transportation of personnel, equipment, and supplies included in the contract from the site, including the disassembly of existing structure in the location assembled on the site specifically for this contract.
2. **Temporary Facilities, Warehouse, Boards.** The temporary buildings for housing workers or the erection of tents or other forms of protection will be permitted only at such places as the university shall designate. If no area is designated, the contractor may use his discretion in determining such areas with the concurrence of the university. The sanitary condition of the project site shall always be maintained in a manner satisfactory to the university.
3. **PPE.** The equipment worn to minimize hazards that cause serious workplace injuries and illnesses.
4. **Signages.** Workplace safety signage is a requirement on all construction sites. Highly visible safety signs can help prevent injuries and ensure that all staff and visitors are aware of any dangerous hazards.
5. **Fences.** These shall be built of an approved material, not less than 2.40 meters in height above grade, and placed on the side of the walkway nearest to the building



- site. Fences shall enclose the building site entirely. Openings in such barriers shall be provided with doors and kept always closed.
6. **Canopies.** The protective canopy shall have a clear height of 2.40 meters above the railway and shall be structurally safe. Every canopy shall have a solid fence build along its entire length on the construction site. If materials are stored, or work is done on top of the canopy, the edge along the street shall be protected by a tight curb board not less than 30 millimeters high. The entire structure shall be designed to carry the loads imposed upon it. Provided that the live load shall be not less than 600 kilograms per square meter.
  7. **Maintenance and Removal of Protective Devices.** All protective devices shall be adequately maintained in place and kept in good order for the entire length of time pedestrians may be endangered.
  8. **Removal.** Every protective fence or canopy shall be removed within 30 days after the protection is no longer required as determined by the implementing office.
  9. **Minimum Testing Requirements.** Quantity stated in the program of works is the basis of the minimum testing requirements for each project. The requirements specify the kind and number of tests for each item and size; this would indicate only the minimum and shall not be the basis of several trials. When a government representative inspected a project, and there is a doubt in the test, he can do another testing immediately.

## **Part 2: Civil, Electrical, Sanitary/Plumbing, & Mechanical Works**

1. Earthworks
2. Site Preparation Works, Demolition of existing Structure/Clearing
3. Excavation Works.
  - a. Excavation or fills for building or structures shall be constructed or protected not to endanger life or property.
  - b. When the excavation would affect the stability of the lateral and subjacent support of the adjoining property or existing structure, the person undertaking or causing the excavation shall be responsible for the expense of underpinning or extending the foundation or footing of the property, as mentioned earlier.
  - c. Excavation and other similar disturbances made on public property shall, unless otherwise excluded by the implementing office, be restored immediately to its



## PROPOSED CONSTRUCTION OF LEARNING RESOURCE CENTER, PHASE 2

RSU-MAIN CAMPUS

former condition within 48 hours from the start of such excavation and disturbances by whosoever caused such excavation or disturbance.

#### 4. Civil Works

- Backfilling Works, ABC
- Boulders 6
- Gravel Bedding, G1
- Soil Poisoning
- Plain and Reinforced Concrete Works (Class A, 28 days)
- Steel Reinforcement Works (Grade 40 & 60)
- Steel Decking Works (Gauge 50)
- Forms & Scaffolding Works
- Finishing Works
- Masonry Works
- Plastering Works
- Carpentry Works, Ceiling, CR Ceiling & Phenolic boards CR Partition
- Welding Works, Stair handrail & Fire exit ladder all levels two sides
- Mill Works (Doors and Windows) with a complete glass and glazing hinges & locksets
- Tile works, beads, and moldings on all levels, including corridors
- Painting works, preparation, treatment, and surface correction up to complete coatings
- Water Proofing Works, all wet areas with concrete toppings 2 thick.
- Ceiling all levels, Gypsum board, T runner

#### 5. Electrical Works, pipes, wires, and fixtures

#### 6. Sanitary/Plumbing Works, pipes to fixture

- Elevated Water S/S 3200 liters w/pipelines from deep well w/pressure tank & motor
- Deep Well Drilling Works, 5 O B1 Pipes with motor 1.5 HP & pipelines from well up to elevated tanks
- Septic Tank & Cistern Tank, 2m x 7m x 2m depth

#### 7. Fire Protection: Dry stand pipelines, firehose on cabinets, fire extinguisher, fire alarm bell, the smoke detector on all levels, Jockey Pumps, Booster pump, and Sprinkler system.



### ***The enclosure of Vertical Openings***

#### ***General.***

Vertical openings shall be enclosed depending upon the fire resistive requirements of a particular type of construction as outlined in the Fire Code of the Ph.

### **Part 3: Cleanup and Demobilization**

The contractor shall ensure that the construction site and the building itself is well cleaned up, such temporary structures used during construction is disassembled, before the certificate of completion to be released.

## **B. DESIGN PARAMETERS**

### **ARCHITECTURAL DESIGN PARAMETERS**

- Shall provide accessibility for the disabled in the design of the building.
- The design of the building shall incorporate provision to maximize energy efficiency and conservation (natural lighting).
- The building shall be oriented appropriately considering sun, wind, site water run down, and specifically typhoon wind direction.
- The building shall be located beside the **Data Center**.
- The building shall adhere to architectural principles of beauty, strength, and utility.
- The building shall be designed considering the ease of maintenance, including durability, function.
- Must include the provision for fire escape in the design of the building under the new fire code of the Philippines.
- Shall observe the design requirements of the national building code of the Philippines (PD 1096), B.P. 344 Accessibility Law, Fire Code of the Philippines, Structural Code, Plumbing Code, and Electrical Code, Mechanical Code.
- Building design should follow the **Latest National Structural Code of the Ph (NSCP) requirements, up to magnitude 8.4 for those near the seismic source type A.**
- Other considerations shall be access road, lighting provision, and building information.
- Consider Harmonized Gender and Development Guidelines (**HGDG**) Standards.

#### **1.1 General**

- All drawings shall be computer – drafted. These shall be submitted both in printed and electronic copies.



## PROPOSED CONSTRUCTION OF LEARNING RESOURCE CENTER, PHASE 2

RSU-MAIN CAMPUS

- Keep the same orientation for all plans. It shall indicate the north orientation in all architectural floor plans. The orientation of the architectural plans shall be consistent with all the engineering plans.
- Existing buildings and new works shall be indicated and labeled in the site plans.
- Detailed plans shall have a scale not smaller than 1:50 meters.
- Spot detailed plans, elevations, and sections shall have a scale not smaller than 1:10 meters.
- Avoid notes such as “see architectural detail” or “see structural”. Always refer with a callout to the specific detail drawing and number.
- Shall provide walk through presentation.

### 1.2 Site Plans

- The site plans shall have a scale not smaller than 1:400 meters.

### 1.3 Floor Plans

- All plans shall have a scale not smaller than 1:200 meters. The contractor shall use the same scale for the rest of the architectural, structural, sanitary, plumbing, electrical, and mechanical plans, except for each trade’s site plan, detailed plans, and spot details.
- He shall indicate the elevation callouts on the floor plans and be consistent with the elevation drawing.
- Section line callouts on the floor plans shall be consistent with the section drawing.
- Floor plans shall be indicated with boxed room callout numbers, including the callout for floor finishes and wall finishes.
- He shall indicate the floor elevations in the floor plans. The elevation shall be in reference to the natural grade line or the established finished floor lines of the adjoining existing buildings.
- He shall indicate the location of mechanical equipment, e.g., air conditioning, in the floor plans. It shall be consistent with the mechanical and electrical plans.
- Door callouts shall be in circles with the proper numbering, e.g., D-01.
- Windows callouts shall be hexagons with the proper numbering. e.g., W-01.
- Indicate the column grid lines in the plan.

### 1.4 Elevations and Sections

- Finish floor lines and roof lines shall be consistent in all the elevations, sections, structural plans, and details.



## PROPOSED CONSTRUCTION OF LEARNING RESOURCE CENTER, PHASE 2

RSU-MAIN CAMPUS

- Architectural annotation or exterior finishes proper label in the drawing.

### 1.5 Reflected Ceiling Plans

- Reflected ceiling plans shall be indicated with boxed room callout numbers, including the callout for ceiling finishes and lighting fixtures.
- The Contractor shall include the Ceiling height relative to the finish floor line in the reflected ceiling plans in each room with boxed dimensions.
- The description and locations of the fixtures, e.g., lighting, smoke detectors, air conditioning vents, exhaust fans, in the reflected ceiling plans shall be consistent with the electrical and mechanical plans.
- Indicate the drawing a point used for setting out the ceiling.

### 1.6 Doors and Windows

- Door and window schedules shall indicate the type of door or window, the number of sets, the location/s of the door and window, the materials and accessories included, and other special specifications, e.g., color or finish.
- Provide the dimension of the doors and windows and the height of the windowsill from the finish floor level.

### 1.7 Details

- Provide a minimum of one (1) bay section of a scale not smaller than 1:50 meters for each major building, preferably cut along the area with a special construction design.
- Provide spot detail plans, elevations, and sections of a scale not smaller than 1:10 meters for special designs with aesthetic treatment and ornamentation.
- Provide spot detailed plans of a scale not smaller than 1:50 for all areas needing tile pattern, e.g., corridor, entrance walk, showing the position and pattern of tiles.
- The Contractor shall indicate the centerline location of plumbing fixtures in detailed plans with lines of reference and its corresponding dimensions to show the exact areas of the plumbing/sanitary roughing-ins.

### 1.8 Building Architectural Works

#### Floor Plans

1. The structural, sanitary, plumbing, electrical, and mechanical designs must refer to the architectural plans and specifications in case of discrepancies.





## PROPOSED CONSTRUCTION OF LEARNING RESOURCE CENTER, PHASE 2

RSU-MAIN CAMPUS

2. The architectural and engineering plans shall be consistent throughout in terms of dimensions and locations of columns, beams, walls, roofline, conduits, ducts, pipes, and fixtures, among others. Column and beam gridlines shall also be consistent in all the architectural and engineering plans.
3. Verify and coordinate floor plans with the mechanical, electrical, and sanitary design concerning mechanical rooms, electrical rooms, pipe chase, and other engineering requirements.
4. Public toilets shall have provisions and fixtures for person with disability as required by BP 344. If enough space allows toilets specially made and designated for persons with disabilities are preferable.

### Walls

1. Exterior walls shall be **150 mm thick**, while interior walls shall be **100 mm thick**. The finished wall thickness includes plastering and tile works.
2. All wall tiles' layout and work must be aligned, plumb, level, and square.
3. All toilet tiles' edges, corners, and intersections, including topmost tile not reaching ceiling, shall be provided with polyvinyl chloride tile trims.
4. All concrete-finished walls are painted with appropriate colors. The color and design shall be approved first before installation.
5. Plaster works shall be finished level, plumb, square and true to line within the tolerance of 3mm in 3.0 meters. Plaster walls are without cracks, waves, blisters, pits, discoloration projections, and other imperfections.

### Floors

1. Suppose floor tiles in two adjacent rooms with different materials, colors, or designs meet at the door opening. In that case, the contractor can use a threshold at the door to have a good termination between different materials. Provide floor pattern design showing the tile setting out point.
2. Second Floor to floor elevation shall be **3.00 m**.
3. Floor at the openings of toilets for PWD shall be sloping. Indicate the plans and sections.
4. The size of the toilet floor tiles shall be 300 mm x 300 mm. Indicate the pattern. **Submit material approval providing sample or product description.**



## PROPOSED CONSTRUCTION OF LEARNING RESOURCE CENTER, PHASE 2

RSU-MAIN CAMPUS

5. The size of floor tiles of the offices shall be **600mm x 600mm**, or more considerable depending on the proportion to the size of the room. Indicate the tile pattern. Submit material approval providing sample or product description.
6. The size of the floor tiles of the lobby and receptionist shall be 600mm x 600mm, Indicate the pattern. Submit material approval providing sample or product description.
7. The size of the floor tiles outdoor entrance walk shall be 600mm x 600mm. Indicate the pattern. Submit material approval providing sample or product description.
8. All exterior tiles are in matt finish and provide a setting out plan for approval.
9. All stairway steps are provided with anti-slip nosing, tiles with built- in anti-slip features, aluminum or brass metal nosing.
10. The layout and work on the wall and floor tiles must be aligned, plumb, level and square.
11. Tile color and design shall be approved first before installation.

### Doors and Windows

1. Main entrance access door shall be see-through, e.g., Glass Door.
2. Toilet Doors shall be wood door.
3. Pantry Door shall be wood and seamless through the wall design of the receptionist.
4. Fire escape door should be provided with panic hardware and door closers and shall conform to the requirements of the Fire Code of the Philippines.
5. The door finish and color shall be approved first before application.
6. Toilet windowsills shall be slightly sloped outwards to prevent damage to windows and paint due to water seepage. Section details shall be required to show this slope.
7. Main entrance door shall swing outwards and as required by the Fire Code of the Philippines.
8. All door jamb width is same as the width of the plastered wall and encases with an architrave on both sides. **Provide details.**
9. **All Doors and windows shall have reinforced concrete lintel beams.** Provide details.

### Stair and Ramps

1. Ramps for persons with disabilities shall have a slope not higher than **1:12**. Stainless Steel Handrails and clearances shall **conform to the requirements of BP 344**.
2. Regular stairs have risers at 180mm high and thread at 300 mm wide. Fire exit stairs could have minimum riser at 150mm high and thread at 300mm. Handrails shall be 1100mm high.
3. Clearance shall **conform to the requirements of the Fire Code of the Philippines**.



4. Exit door shall conform to the requirements of the Fire Code of the Philippines.

#### Fixtures and Accessories

1. Three-way electrical light switches shall be provided at the foot and the top of the stairs per floor.
2. Electrical light switches shall be located by the knob side of the door.
3. Electrical switches and outlets shall be installed plumb and level.
4. Public toilet shall always be provided with stainless handrails in conformity to the requirements of BP 344. All plumbing fixtures must be submitted for approval.

#### Roofing Works

1. Provide membrane-type waterproofing for the roof deck, toilets, and other wet areas. Submit details of waterproofing. Submit material sample or product supplier and on-site mock-up for approval if required.
2. Parapets, designed for roof protection from winds, must be designed to satisfy the preceding parameters.
3. Submit material sample or product supplier and on on-site mock-up for approval if required.

#### Painting

1. The painted ceiling shall be flat latex.
2. Painted interior walls shall be in semi-gloss finish.
3. Painted exterior walls shall be in moisture-resistant/water-repellent solvent-based paint finish, textured or smooth unless otherwise specified.
4. Paint color and shade shall be approved first before application.
5. Submit a schedule of rooms for painting applications, including walls and ceilings. Start with surface preparation to finish the application. Need a material approval submission.

#### 1.9 Specific Requirements

Provide spot detail plans and sections of the following:

1. Eaves and parapet
2. Ceiling cover light, special connections, design, mouldings.
3. Stairs-handrail, and baluster design.
4. Ramps – handrail design and floor pattern
5. Doors, windows and gates – grille works,



6. Special architectural treatment and design, e.g., façade design, special window, and door.
7. Special Carpentry Works, e.g., partitions, cabinet
8. Details of roof drain
9. Other information as may be required.

#### 1.10 Summary of Materials

- Materials to be used shall be fire-resistant, non-toxic, moisture-resistant, and termite-resistant, e.g., fiber cement board, light-gauge steel frame, polyvinyl chloride ceiling panels, metal spar.
- Wet areas, e.g., toilets, and kitchens, shall use non-skid/ non-slip vitrified ceramic floor tiles.
- Ramps and stairs shall use non-skid/non-slip floor tiles materials as specified.
- Aluminum T-runners shall be powder coated.
- Metal rod hangers with adjustable clips and not galvanized iron wires shall support and suspend the aluminum T-runners and light gauge metal furring.

#### Structural Design

- The Designer shall prepare the necessary structural analysis/calculation and design of the structural members (Foundation, Columns, Girders, Beams, Slabs, and others) under the National Building Code of the Philippines with its referral code such as the National Structural Code of the Philippines. The Design of the structure shall take into account, among other things, the seismic requirements of the area to determine the optimum safety of the whole structure and to minimize possible earthquake damage. The Design must consider the occurrence of flooding in the site and the Typhoon strength for the MIMAROPA Region.
- The Designer shall perform Site Investigations, topographical/engineering, soil investigation, a survey of existing site conditions, the seismic requirements of the area, and other investigation required to obtain the data necessary to ensure safety of the structure.
- The seismicity of the location belongs to zone 4. Proposed **Construction of Learning Resource Center, Phase 2** should be design using seismic importance factor of 1.5 for the occupancy Category I (Essential Facilities) – Public School). Buildings should be designated in accordance with the NSCP requirements up to Magnitude 8.4 for those near seismic source Type A. Seismic gaps between buildings (old and new) should be appropriately observed. Its structural system or Lateral – Resisting System Description shall be based on Special – Moment Resisting Frame (SMRF)



## PROPOSED CONSTRUCTION OF LEARNING RESOURCE CENTER, PHASE 2

RSU-MAIN CAMPUS

- The structural Designer must verify the distance of the **CONSTRUCTION OF THE HEALTH AND WELLNESS BUILDING PHASE I** to the nearest active fault lines from the PHILVOLCS and DENR geo-hazard mapping.
- The building should also be designed using a wind importance factor of 1.0, a basic wind speed of 300kph, and at Exposure B.
- All Structural Steel works shall be according with latest American Institute of Steel Construction (AISC) specifications in so far as they do not conflict with local building requirement.
- It is required that the interpretation and evaluation of the results of the foundation investigation upon completion shall be made by the registered civil engineer, experienced and knowledgeable in the field of geotechnical engineering. Soil classification shall be based on observation and any necessary tests of the materials disclosed by borings or excavation made in appropriate location. Allowable Bearing Capacity shall be found on the Boring Test at the building site. (Refer to **ANNEX E: PRELIMINARY INVESTIGATIONS (FOUNDATION DESIGN AND RECOMMENDATIONS)**)
- The structural designer is encouraged to use fire-resistive and non-toxic materials.
- The Dead Loads to be considered in the design must conform to the Section 204 of NSCP 2015 and must include the equipment to be installed in the building.
- The live loads to be considered in the design must conform to Section 205 of NSCP 2015 that are not limited to the following:
  - i) Ground Floor – *see attached plans*
  - ii) Second Floor – *see attached plans*
  - iii) Third Floor – *see attached plans*

*During construction the contractor shall poured first a **lean concrete** equal to the thickness of the concrete cover of the foundation prior to fabrication of steel reinforcement of all reinforced structural concrete that will rest in the ground.*

2.1 Details – the following shall be provided:

- Connection details of foundations, columns and beams following the requirements of NSCP on confined areas.
- Detailing Requirements in seismic Zone 4 shall include the provision of confinement/hoops proportioned to resist earthquake-induced shear force.
- All welds types, sizes, lengths and strengths.
- All bolt sizes, locations, quantities and grades.
- All plate and angle sizes, thicknesses, dimensions and grades.
- All work point locations and related information.

2.2 Summary of Materials



## PROPOSED CONSTRUCTION OF LEARNING RESOURCE CENTER, PHASE 2

RSU-MAIN CAMPUS

- All Concrete shall use Portland cement and conform to ASTM Specifications C150, Type I to Type II and shall develop a minimum compressive strength at 28 days of 4000Psi.
- Coarse Aggregates shall consist of washed gravel, crashed stone and rock, or a combination thereof to ASTM C33.
- Concrete Hollow blocks shall be a standard product of recognized manufacturers conforming to PNS 16 with 400Psi minimum compressive strength for non-load bearing while 750Psi minimum compressive strength for load bearing blocks.
- Reinforcing Steel bar shall conform to ASTM 615 Grade 60 for 16mm diameter and above and Grade 40 for 12mm diameter and below. Mill Certificate of the reinforcement shall be submitted for review of the Inspectorate Team.
- Structural steel shall conform with ASTM A36/A36M
- Bolt and Studs shall conform with ASTM A325
- All welding of reinforcement shall be conformed to the provisions of the structural Welding code reinforcing steel AWS and electrodes shall be E60 or E70.
- Columns and Beams shall use Grade 60 I-beams/H beams as steel reinforcement with ties and poured with concrete conforming to the standards. (Composite Columns and Beams)
- Slab shall design using steel decking with reinforcement steel bar.

### Sanitary and Plumbing Works Design

- The designer shall carry out a detailed design for the building's water supply, drainage, and sewer system. The design should be based in the results of the hydrological study and the drainage survey taking into consideration the general problems such as the source and the volume of water supply, water consumption, piping network, drainage discharge area, and conveyance and treatment of sewer flow, in accordance with the applicable laws, rules, and regulations governing health safety and sanitation.
- All Plumbing Works included shall be executed according to the provision of The National Plumbing Code of the Philippines and Local Rules and Regulation.
- All vertical piping shall be supported at every one (1) meter interval.
- All horizontal piping shall be supported by stiff metal backing hangers in its entire length for small size tubing up to 38mm diameter and without backing but with spaced metal hangers at approved for larger-size tubing.
- Plumbing fixtures shall be manufactured of dense, durable, non-sorbent materials and have smooth, impervious surfaces, free from unnecessary concealed fouling surfaces, except as permitted elsewhere in this code, all fixtures shall conform in quality and national recognized applicable standards.
- Water supply will be sourced from the Local Water sources.
- Water outlets should be provided in convenient locations for the cleaning / flushing.



## PROPOSED CONSTRUCTION OF LEARNING RESOURCE CENTER, PHASE 2

### RSU-MAIN CAMPUS

- All valves which are concealed and or installed in the ceiling shall be provided with access manhole.
- Main water tapping point is clearly identified on the plan. (gate valve, y-strainer, water meter, check valve)

#### 3.1 Building facilities Sanitary/Plumbing System

##### Sewer line and Vent System

- Provide complete Sewer line and vent System from all plumbing fixtures and floor drains; laid by gravity flow leading to the Septic Tank.
- Wastewater lines shall use Unplasticized Polyvinyl Chloride (UPVC) Series 1000 pipes and fittings.
- All ACCU units located at the right side of the Powerhouse shall be provided with sufficient drains.
- All FCU drains are tapped at storm/drainpipes.
- Change in direction of drainage piping shall be made by the appropriate use of approved fittings.
- For Drainage Fixtures Units, refer to Chapter 7, Table 2, NPCP.
- Septic tank shall be made of 200mm thick reinforce concrete wall with water proofing and covered of reinforced concrete slab with manhole provision.
- The septic tank dimensions shall be designed based on computation stated in the NPCP.
- The septic tank shall be composed of (3) three chambers such as (1) digestive chambers with concrete flooring, (1) leaching chamber with rubbles flooring, (1) cleansing chamber with charcoal flooring. The septic tank cover and outlet pipes shall be elevated from the finish floor line minimum of 1 ft.

##### Water line System

- Provide complete cold water supply pipes to all plumbing fixtures. From the main water source and the water shall be stored in a concrete base tank and shall pumped by electric water pump to the stainless overhead water tank located roof deck and conveyed to the fixtures by a gravity system.
- Water Supply lines shall use Polypropylene random Co-Polymer Type 3 Pipes, gate valves and fittings.
- Water tank shall be made of 200mm thick reinforce concrete wall with water proofing and covered of reinforced concrete slab with manhole provision.
- Water storage tanks size shall be calculated based on the standards.

##### Storm Drainage System

- Complete Storm Drainage System shall be provided for the roof deck, canopies, and balconies, including drains laid for gravity flow connected to a leader/pipeline leading to the natural Ground level storm drainage network.
- Provision shall be made for the future installation of rainwater collection systems in compliance with R.A. No. 6716.



### **Water line System**

Provide complete cold water supply pipes to all plumbing fixtures. From the main water source and the water shall be stored in a concrete base tank and shall be pumped by electric water pump to the located roof deck and conveyed to the fixtures.

### **Storm Drainage System**

Complete Storm Drainage System shall be provided for the roof deck, canopies, and balconies, including drains laid for gravity flow connected to a leader/pipeline leading to the natural Ground level storm drainage network.

Provision shall be made for the future installation of rainwater collection systems in compliance with R.A. No. 6716.

### **Electrical Works Design**

- The Designer shall prepare a design for the building's electrical and power supply system following the Philippine Electrical Code, Fire Code of the Philippines, and the National Building Code of the Philippines
- The Designer shall prepare a design for the electrical and power supply system considering ease of maintenance and preventing illegal connections.
- The Designer shall include a temporary power supply for the entire construction (rent or purchase a single phase 10kVA transformer from the electric utility)
- The Designer shall include Private Poles and pad-mounted transformers (including pole accessories such as LBS, CT, PT, Lighting Arrester, and metering system and shall be tapped in the nearest pole in TIELCO primary line.
- The Feeder line (primary/secondary) from the utility pole to the service entrance of the building shall be enclosed by concrete encasement via PVC conduit underground.
- Primary cable must be 15kV rated and enclosed through concrete encasement and concrete pedestal from transformer primary to pole fuse cutout.
- The Main Transformer must be placed inside the powerhouse, and the transformer must be pad-mounted.
  
- The Electrical systems include lighting, emergency lights, exit lights, single-phase outlets, mechanical power supply, and other equipment needed in the building.
- Learning Resource Center equipment power supply in the building is also included.





## PROPOSED CONSTRUCTION OF LEARNING RESOURCE CENTER, PHASE 2

RSU-MAIN CAMPUS

- The secondary/working system shall be three phase 220V, 60Hz to supply, library equipment and other essential loads.
- The Electrical System must have a grounding system and equipment grounding (including grounding terminals) with the earth resistance below 5 Ohms
- Rooms, corridors, hallways, and perimeter illumination and ventilation shall pass the illumination and ventilation standards/requirements.
- Primary Pad Mounted Transformer, Generator, ATS, and Main Panel Board shall be enclosed in a concrete structure or Power House.
- The Powerhouse must have lighting, service CO, Emergency Light, and Proper Ventilation and this includes a generator muffler and radiator exhaust duct.
- The Electrical System must accommodate the fire sprinkler system and must follow the standard rule "first disconnect".
- The Designer shall place the Emergency, Exit lighting Fire alarm panel, bells, sounders, and manual call points (MCP) in a strategic location that will meet the BFP requirements in the occupation permit.

### Mechanical Works Design

The Designer shall prepare a design for the **Automatic Fire Sprinkler System**, Ventilation and Air Conditioning System inside in accordance with the National Building Code of the Philippines and its new IRR, Fire Code of the Philippines, and Mechanical Engineering Code of the Philippines (ME Code)

- The Fire Detection and Alarm System shall be composed of multiplex, microprocessor-controlled addressable or semi-addressable, zonal conventional fire detection, alarm, and communication systems.
  - The alarm system shall be on every floor level.
  - The system shall consist of full integration automatic fire detection, voice alarm communication, and a fire-fighter's telephone system.
  - The system shall monitor the status of flow switches and supervisory switches installed at the sprinkler system risers. These monitoring points are also addressable or the conventional zone in the same way the detectors make them easily recognizable at the control panel.
  - Occupant notification shall be accomplished automatically. Notification is a general, audible alarm type complying with the appropriate sectioned NFPA – Standard for Portable Fire Extinguishers (1 unit of portable fire extinguishers per room/office).
  - The system shall be installed with provisions for future connection to the nearest fire service station in the locality.
  - Installation of Class III Fire Cabinet and Cistern tank with pump.
- #### 5.2 Automatic Fire Sprinkler System
- The Fire Sprinkler System for all the spaces. The automatic fire sprinkler system shall be composed of complete plans and drawings of the following:



## PROPOSED CONSTRUCTION OF LEARNING RESOURCE CENTER, PHASE 2

RSU-MAIN CAMPUS

- Site Development Plan and Vicinity Map (e.g., location of the buildings, firewater reserved tank, firewater line, yard loop, and private fire hydrant)
- General Notes, Legends, and Symbols including Schematic Diagram of the Fire Sprinkler System and Schematic Diagram of Alarm Monitoring System.
- Floor Layout and Isometric Layout of the Automatic Fire Sprinkler System (e.g., pipe sizes, location of the pipes, valves, sprinkler heads, riser nipples, fire hose cabinets, main sprinkler riser, drainpipes, cross mains, branch lines, inspector's test connections, hangers, and sway braces)
- Equipment Schedule
- **Detail drawings** (Architectural, Structural, Electrical, and Plumbing drawings of the Firewater Tank and Pump House)
  - a. An automatic fire sprinkler shall be provided. o Hazard Classification shall be Light Hazard Occupancy.
  - b. The protection area per sprinkler head shall be 20 square meters at 2.2 meters minimum distance between sprinklers and 4.2 meters maximum spacing.
  - c. All floor control valves shall be equipped with a supervisory switch, water flow detector, and drain system.
  - d. Minimum number of fire pump and jockey pump must be 2.
  - e. Provide sequence of operation for FP1 and FP2.
  - f. Show the location of fire pump and jockey pump control panel at fire pump room.
  - g. Fire pump with complete accessories. (Vertical turbine for negative suction or horizontal split-case for positive suction.)
  - h. Controller shall monitor pump running, loss of phase or line power, low reservoir, level alarms shall be individually displayed in front of panel by lighting of visual lamps.
  - i. Jockey pump with complete accessories. (Submersible jockey pump for negative suction of vertical multi-stage pump for positive suction.)
  - j. Firewater reserve tanks shall be ground-level monolithic concrete tank size for a minimum of 1 hour.
  - k. Hydraulic calculations report shall be based on NFPA-13 format.

Diesel Firefighting Set complete with diesel main pump, electric jockey pump, pressure tank and control panel. Main Pump

- 1,500 LPM
- 50m Head Jockey Pump
- 33 LPM
- 65M Head
- Electric Pump Specs: 1.1 kw, 1x220V, 2900 rpm Control Panel
- Schneider Pressure Tank
- 100L – 10 bars



**PROPOSED CONSTRUCTION OF LEARNING RESOURCE CENTER, PHASE 2**  
RSU-MAIN CAMPUS

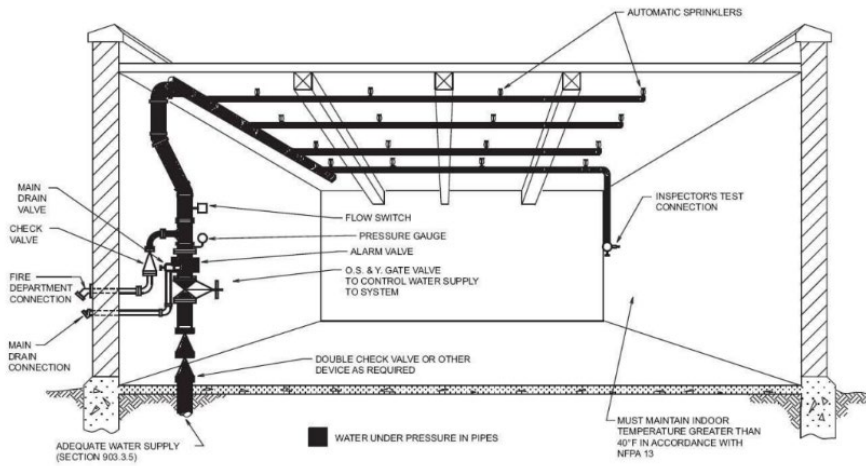

**SHRM VRF Heat Recovery Features**

- 6-ton single-phase modules available
- Capable of simultaneous cooling and heating (flow selector boxes required)
- Modules have 2 inverter-driven twin rotary compressors
- Backup capability due to multiple compressors
- Compressor speed varied in 0.1 Hz increments for comfort and efficiency
- Direct drive, inverter-driven 64-step outdoor motor
- 2 modules can be combined to form 12-ton single-phase system
- Up to 3281 ft (1000 m) actual total system piping (liquid line)
- Up to 591 ft (180 m) actual piping length from outdoor unit to furthest fan coil
- Up to 330 ft (100 m) outdoor control wiring
- Up to 6560 ft (2000 m) control wiring between outdoor and indoor units
- Operating temperature range  
Cooling (db): 14 to 122 F (-10 to 50 C)  
Heating (wb): -13 to 60 F (-25 to 15.6 C)
- Protection: high pressure switch, low pressure sensor and switch, PC board fuse, inverter overload protection
- 7-year compressor limited warranty, 5-year parts limited warranty

Header Unit Model		MMY-MAP0726FT2P-UL
<b>PERFORMANCE</b>		
Rated Cooling Capacity	Btu/h	69,000
Rated Heating Capacity	Btu/h	77,000
Maximum Total Connected Indoor Unit Capacity		Up to 150%
<b>SIMULTANEOUS COOLING AND HEATING EFFICIENCY*</b>		
SCHE, Ducted FCUs		26.90
SCHE, Ductless FCUs		30.60
<b>COOLING EFFICIENCY*</b>		
EER/IEER, Ducted FCUs		12.60/19.50
EER/IEER, Ductless FCUs		14.60/26.60
<b>HEATING EFFICIENCY*</b>		
COP at 47 F, Ducted FCUs		3.42
COP at 47 F, Ductless FCUs		3.67
Fan Type (Qty)		Propeller (1)
Airflow, Standard Range	CFM	6700
Sound Pressure, Cooling/Heating	dBA	57.0/60.0
External Static Pressure†	in. wg	0.24

**LEGEND**

- db — Dry Bulb
- COP — Coefficient of Performance
- EER — Energy Efficiency Ratio
- FCU — Fan Coil Unit
- IEER — Integrated Energy Efficiency Ratio
- SCHE — Simultaneous Cooling and Heating Efficiency
- wb — Wet Bulb

NOTE: Unit cabinet and coil slab shall be capable of withstanding 500-hour salt spray test in accordance with the ASTM (American Society for Testing and Materials, U.S.A.) B-117 Standard.

<b>ELECTRICAL</b>		
Power Supply	V/Ph/Hz	208-230/1/60
Minimum Circuit Amps (MCA)	A	47
Recommended Fuse Size	A	50
<b>COMPRESSORS</b>		
Type (Number)		Inverter Twin Rotary (2)
Motor Output	kW	2 x 2.1
<b>FAN MOTOR</b>		
Motor Type (Steps)		Inverter Direct Driven (64)
Motor Output	kW	1.0
<b>PHYSICAL DATA</b>		
Pipe Connection Size - Liquid (High Pressure)	in.	1/2 (Flare)
Pipe Connection Size - Gas (Low Pressure)	in.	7/8 (Brazed)
Discharge (High Pressure)	in.	3/4 (Flare)
Balance	in.	3/8 (Flare)
Refrigerant		R-410A
Factory Charge**	lb	24.3
External Finish		Munsell 1Y8.5/0.5
Unit Width	in.	39.0
Unit Height	in.	72.9
Unit Depth	in.	30.7
Unit Net Weight	lb	600

\*Rated per AHRI (Air-Conditioning, Heating and Refrigeration Institute) 1230 Standard.  
Cooling: Indoor 80 F (27 C) db/67 F (19 C) wb; Outdoor 95 F (35 C) db  
Heating: Indoor 70 F (21 C) db; Outdoor 47 F (8 C) db/43 F (6 C) wb  
†Requires setting by DIP switches.  
\*\*Additional charge required.

**DIMENSIONAL DRAWING**  
**OUTDOOR UNIT HEAT RECOVERY/SINGLE UNIT MMY-MAP0726FT2P-UL**

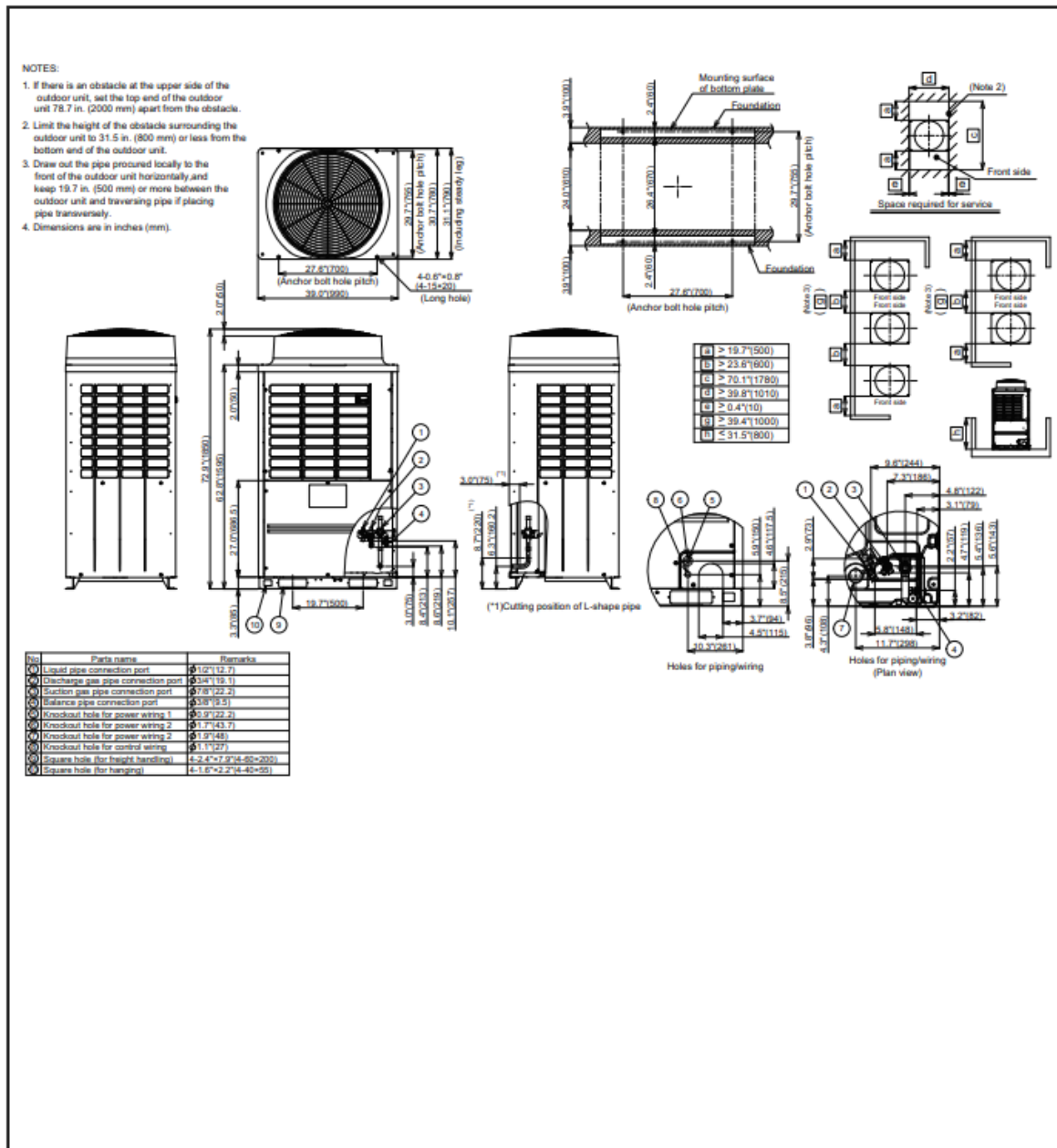

**FIRE DETECTION SYSTEM NOTES:**

1. The purpose of this schematic is to provide a general concept and the principle of the proposed fire detection and alarm system.
2. The quantity and location of devices are indicative only. refer to floor plan layout for final location and quantity.
3. If separate power supply lines are required, provide separate conduit run.
4. all fire suppression system and aspirating type smoke detection system shall be provided with addressable input module contractor to verify actual location & quantity.



## PROPOSED CONSTRUCTION OF LEARNING RESOURCE CENTER, PHASE 2

RSU-MAIN CAMPUS

5. Fire Detection and Alarm Systems (FDAS) contractor shall furnish & install the complete system including wires / cables, accessories, relays & software programming (Fire Alarm Control Panel (FACP) workstation software and others) as deemed necessary for the successful operation of the system.
6. FDAS contractor to provide and coordinate with base build FDAs contractor for the compatibility of the new FDAs devices with the existing FACP.
7. FDAS contractor to ensure that all fire alarm sounder & strobe light are synchronizes FDAs contractor to provide synchronization panel.
8. FDAS contractor to verify if the existing base build FDAs riser can accommodate the new FDAs wiring with maximum 40% fill. Otherwise, contractor to provide additional FDAs riser to accommodate the additional loops or wiring.
9. FACP shall monitor the following status of indicated systems:
  - a. aspirating type smoke detection system:
    - i. general alarm
    - ii. trouble
  - b. fire suppression system:
    - i. fire alarm
    - ii. second alarm
    - iii. trouble
10. T-tap connection is not acceptable; wiring of loop cables shall be done in class “a” configuration and as per manufacturer’s recommendation.
11. Contractor to provide addressable output module or control modules for access control, av amplifiers/panels and other life safety equipment.
12. Contractor to ensure that the FACP and FDAs workstation shall be updated & reprogrammed in accordance with quality & location of FDAs devices, as per design.
13. Contractor to ensure an average of 70dba sound pressure level at the furthest distance from the fire alarm sounder and 65dba inside the enclosed rooms.
14. FDAS contractor to provide interfacing cables if wires going to the party system.



## PROPOSED CONSTRUCTION OF LEARNING RESOURCE CENTER, PHASE 2 RSU-MAIN CAMPUS

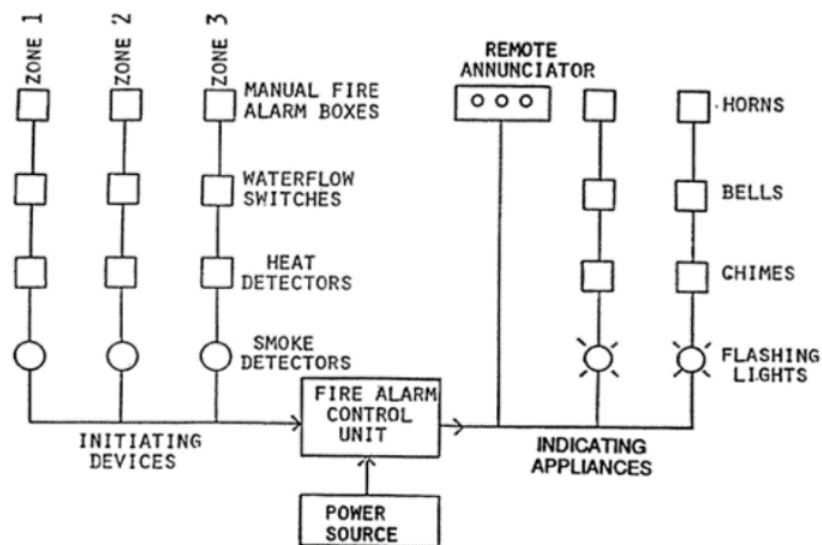

### Network and Communication Works Design Parameters

The Designer shall design the entire building's network cabling system, FDAS, and CCTV system.

The design shall be composed of complete plans and drawings like

- General Notes, Legends, and Symbols, including Schematic Diagrams.
- Floor Layout of the System indicating the capacity and location.



**PROPOSED CONSTRUCTION OF LEARNING RESOURCE CENTER, PHASE 2**  
RSU-MAIN CAMPUS



**PROPOSED CONSTRUCTION OF LEARNING RESOURCE CENTER, PHASE 2**  
RSU-MAIN CAMPUS





## **ANNEX D – PRELIMINARY SURVEY AND MAPPING**



**PROPOSED CONSTRUCTION OF LEARNING RESOURCE CENTER, PHASE 2**  
RSU-MAIN CAMPUS

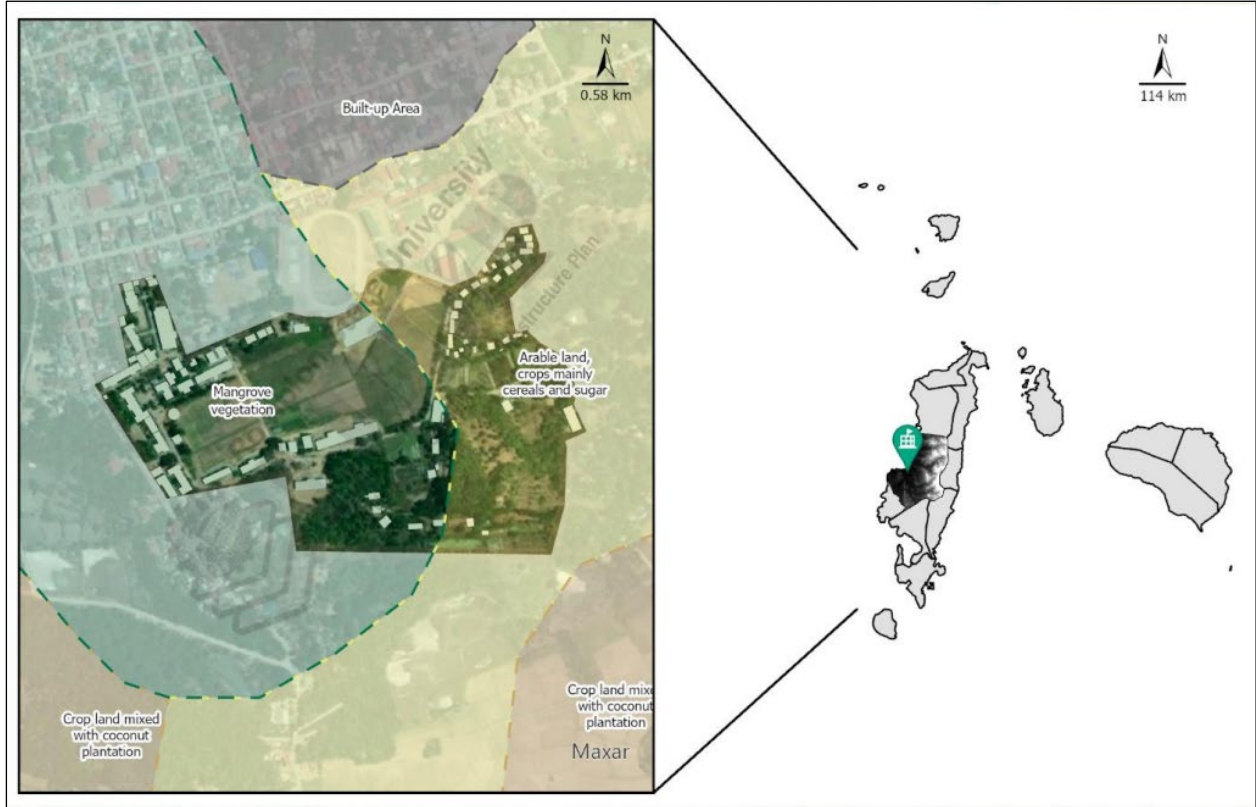

*Figure: Land Cover around Romblon State University - Main Campus*  
*Source: Planning and Development Office*

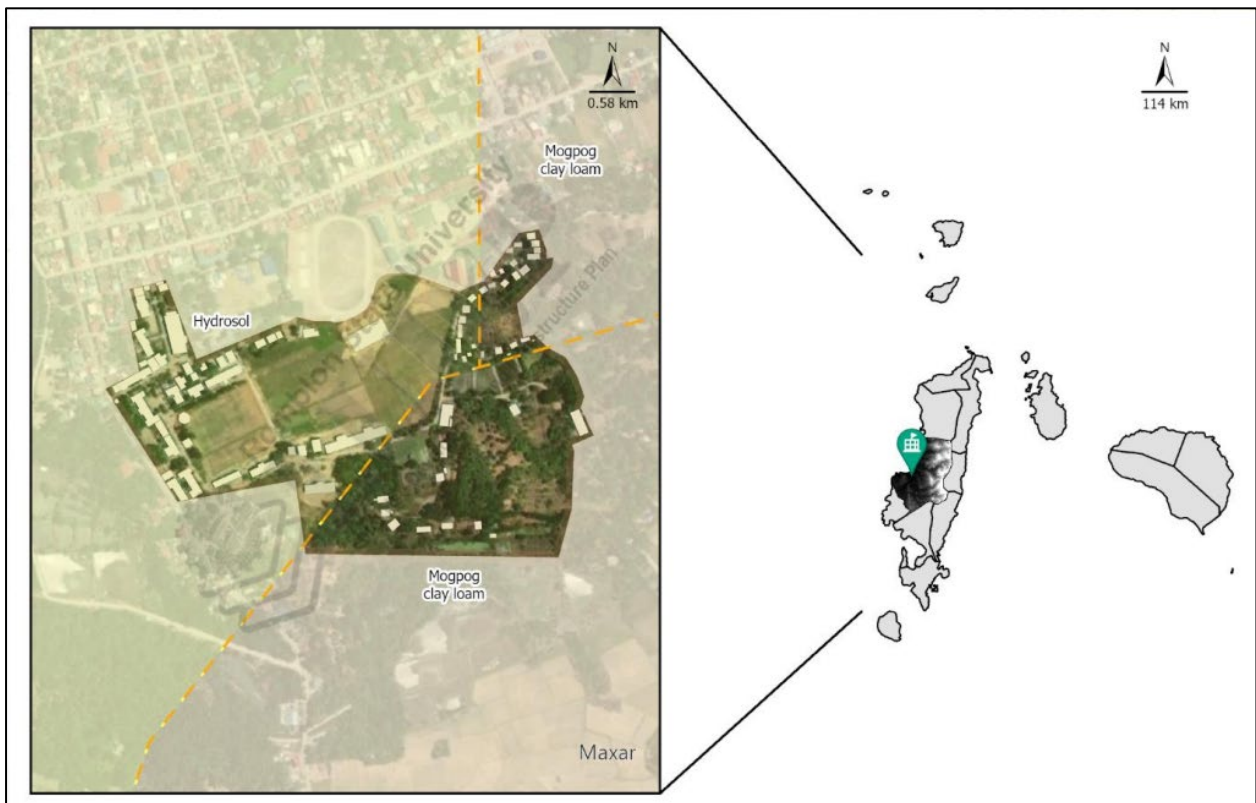

*Figure: Soil texture around Romblon State University - Main Campus*  
*Source: Planning and Development Office*



**PROPOSED CONSTRUCTION OF LEARNING RESOURCE CENTER, PHASE 2**  
RSU-MAIN CAMPUS



Figure: Slope around Romblon State University - Main Campus  
Source: Planning and Development Office



Figure: Waterbody around of Romblon State University - Main Campus  
Source: Planning and Development Office



**PROPOSED CONSTRUCTION OF LEARNING RESOURCE CENTER, PHASE 2**  
RSU-MAIN CAMPUS



Figure: Geohazard around Romblon State University - Main Campus  
Source: Planning and Development Office

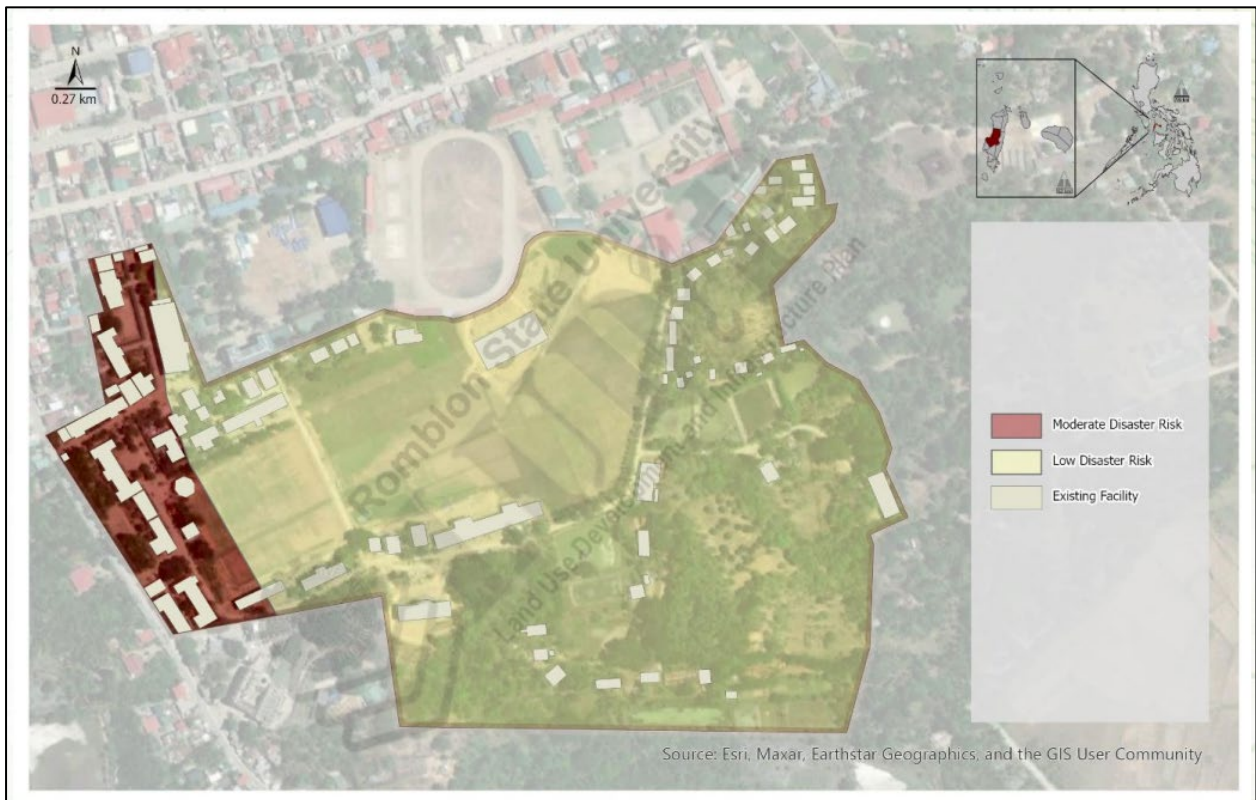

Figure: Disaster Risk Assessment for Romblon State University – Main Campus  
Source: Planning and Development Office



**PROPOSED CONSTRUCTION OF LEARNING RESOURCE CENTER, PHASE 2**  
RSU-MAIN CAMPUS



*Figure: Existing forest and major open spaces of Romblon State University - Main Campus*  
Source: Planning and Development Office

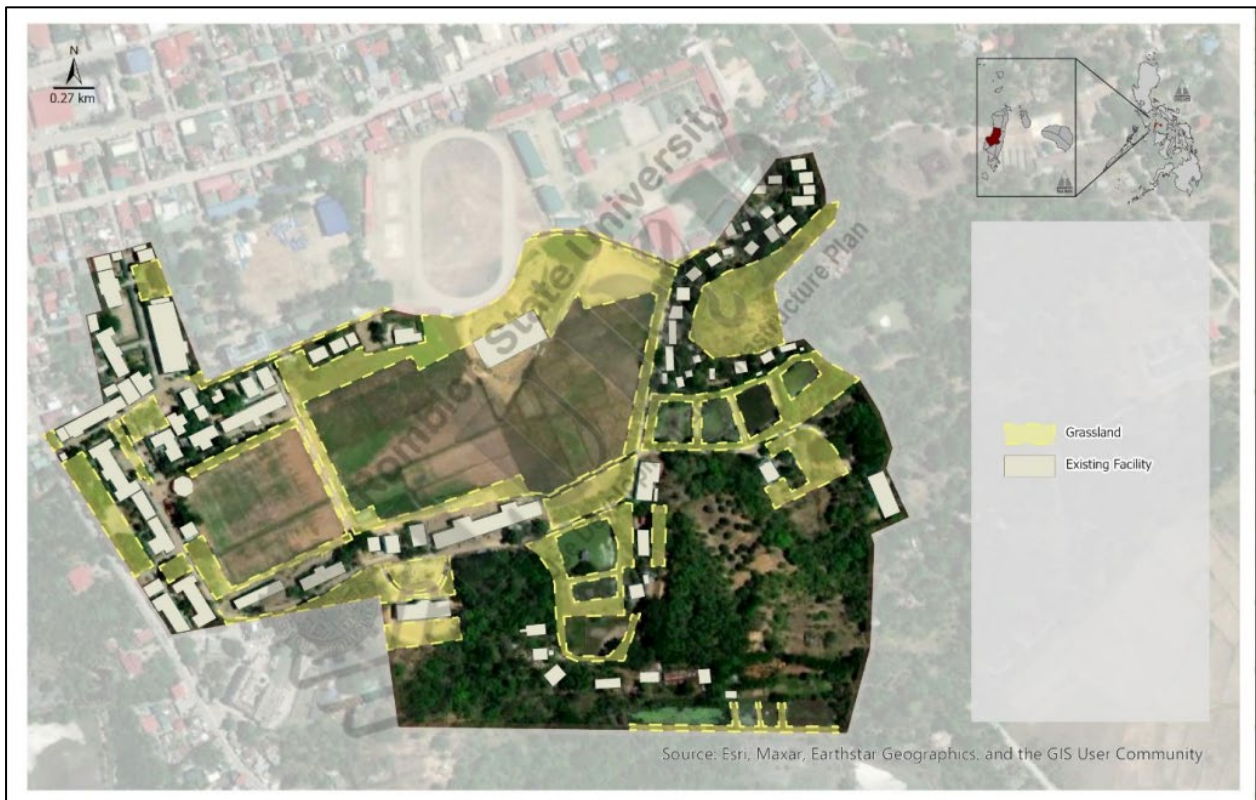

*Figure: Existing grassland areas of Romblon State University - Main Campus*  
Source: Planning and Development Office



**PROPOSED CONSTRUCTION OF LEARNING RESOURCE CENTER, PHASE 2**  
RSU-MAIN CAMPUS



*Figure: Existing cultivated land areas of Romblon State University - Main Campus*  
*Source: Planning and Development Office*



*Figure: Existing major roads of Romblon State University - Main Campus*  
*Source: Planning and Development Office*



**PROPOSED CONSTRUCTION OF LEARNING RESOURCE CENTER, PHASE 2**  
RSU-MAIN CAMPUS



Figure: Existing waterbodies of Romblon State University - Main Campus  
Source: Planning and Development Office

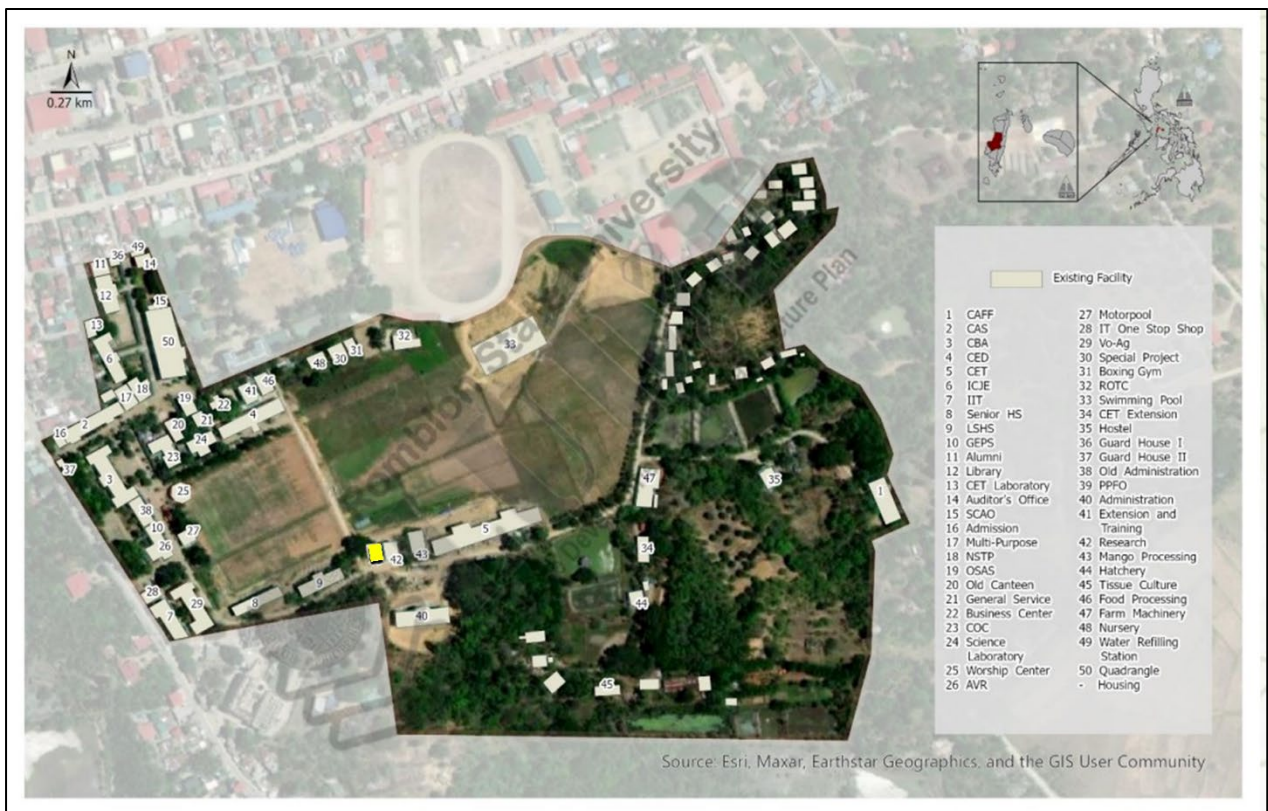

Figure: Proposed Actual Site Location   
Source: Planning and Development Office



## **ANNEX E – PRELIMINARY INVESTIGATION**





**PROPOSED CONSTRUCTION OF LEARNING RESOURCE CENTER, PHASE 2**  
RSU-MAIN CAMPUS

*\*The following data is not available.*



## **ANNEX F – UTILITY LOCATION**



**PROPOSED CONSTRUCTION OF LEARNING RESOURCE CENTER, PHASE 2**  
 RSU-MAIN CAMPUS

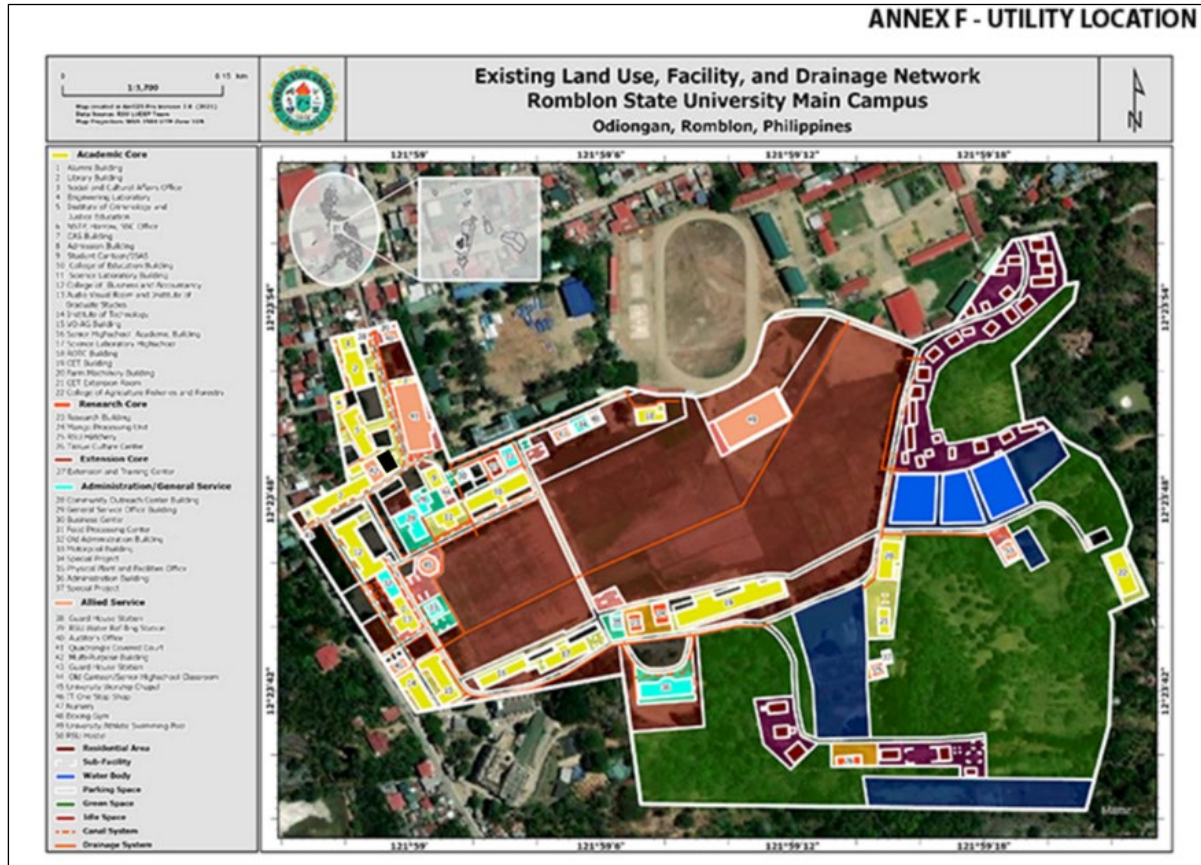

Figure: Existing Drainage Network of Rombon State University - Main Campus



**PROPOSED CONSTRUCTION OF LEARNING RESOURCE CENTER, PHASE 2**  
RSU-MAIN CAMPUS

Source: Planning and Development Office

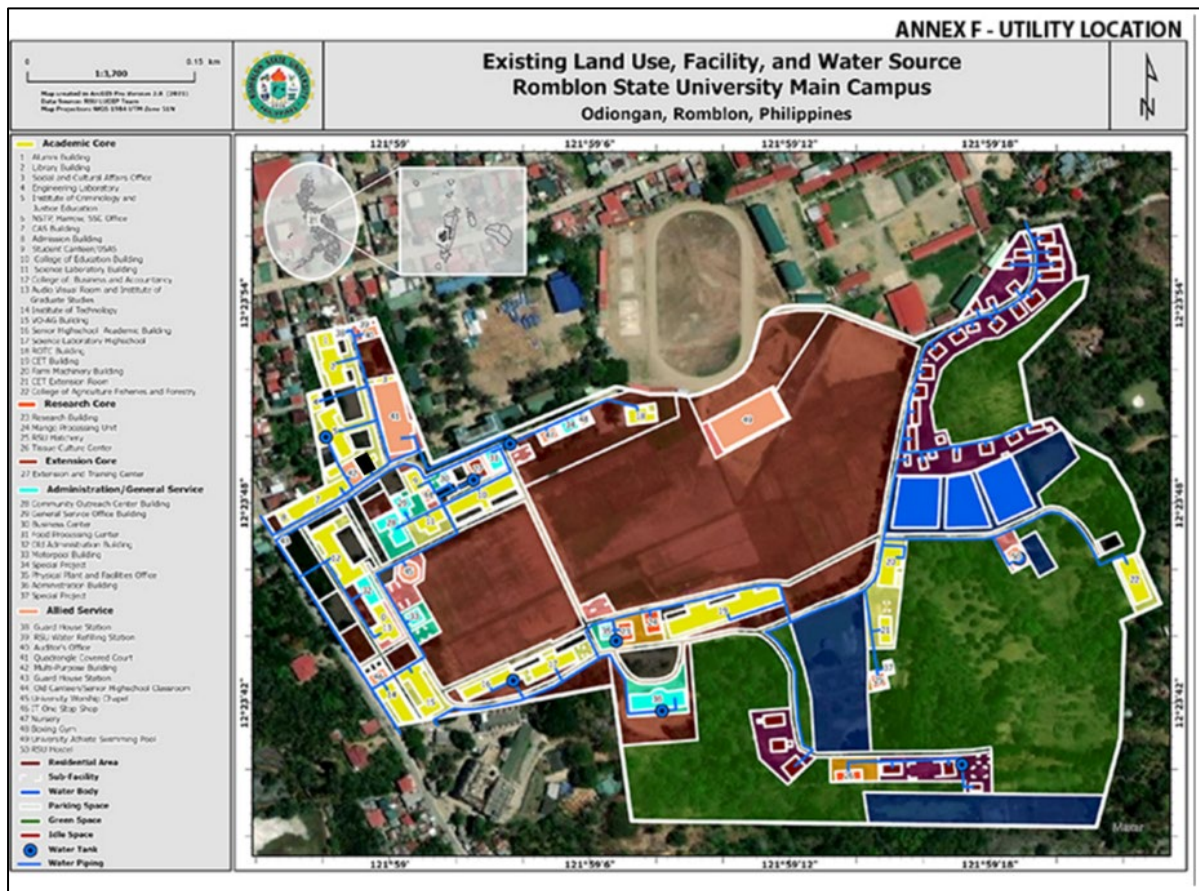

Figure: Existing Water Source of Romblon State University - Main Campus  
Source: Planning and Development Office

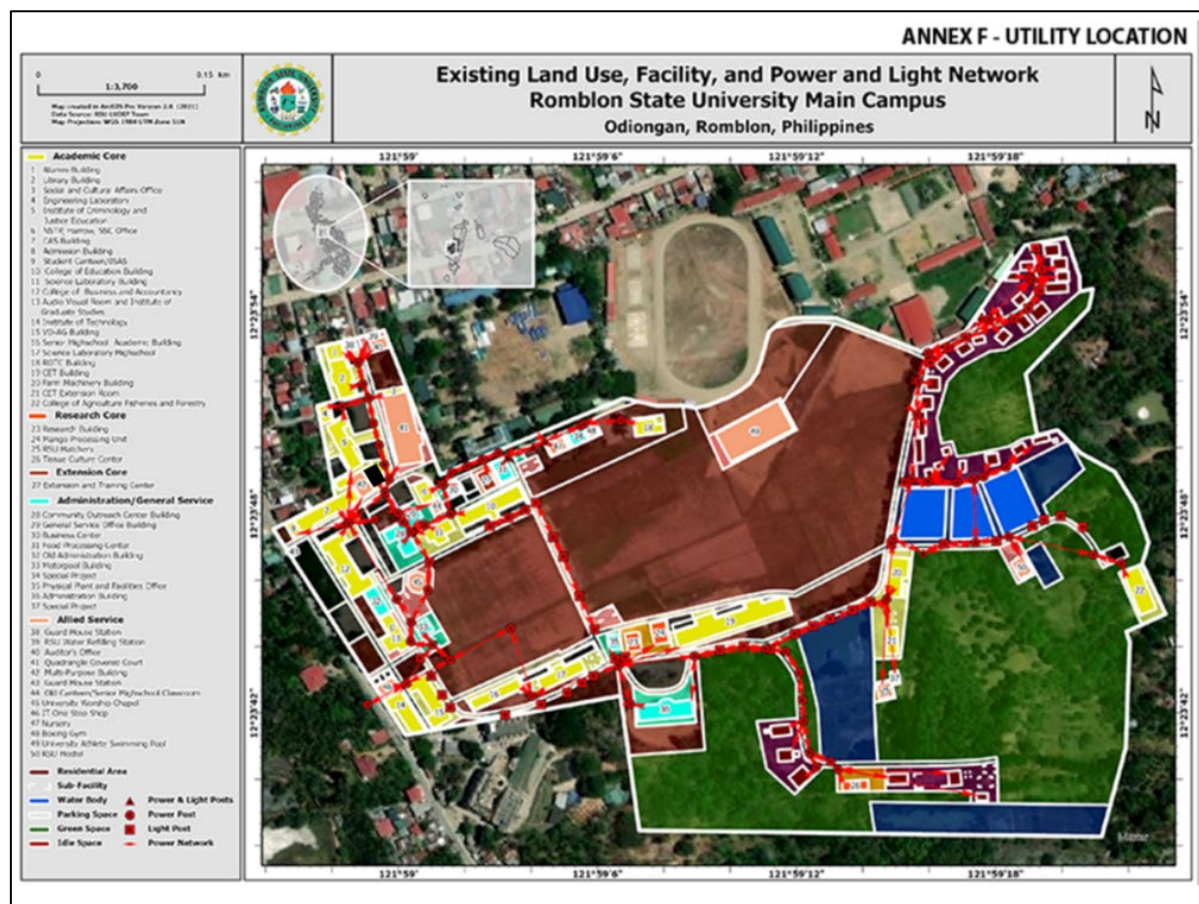

Figure: Existing Power and Lighting Network of Romblon State University - Main Campus



**PROPOSED CONSTRUCTION OF LEARNING RESOURCE CENTER, PHASE 2**  
RSU-MAIN CAMPUS

Source: Planning and Development Office

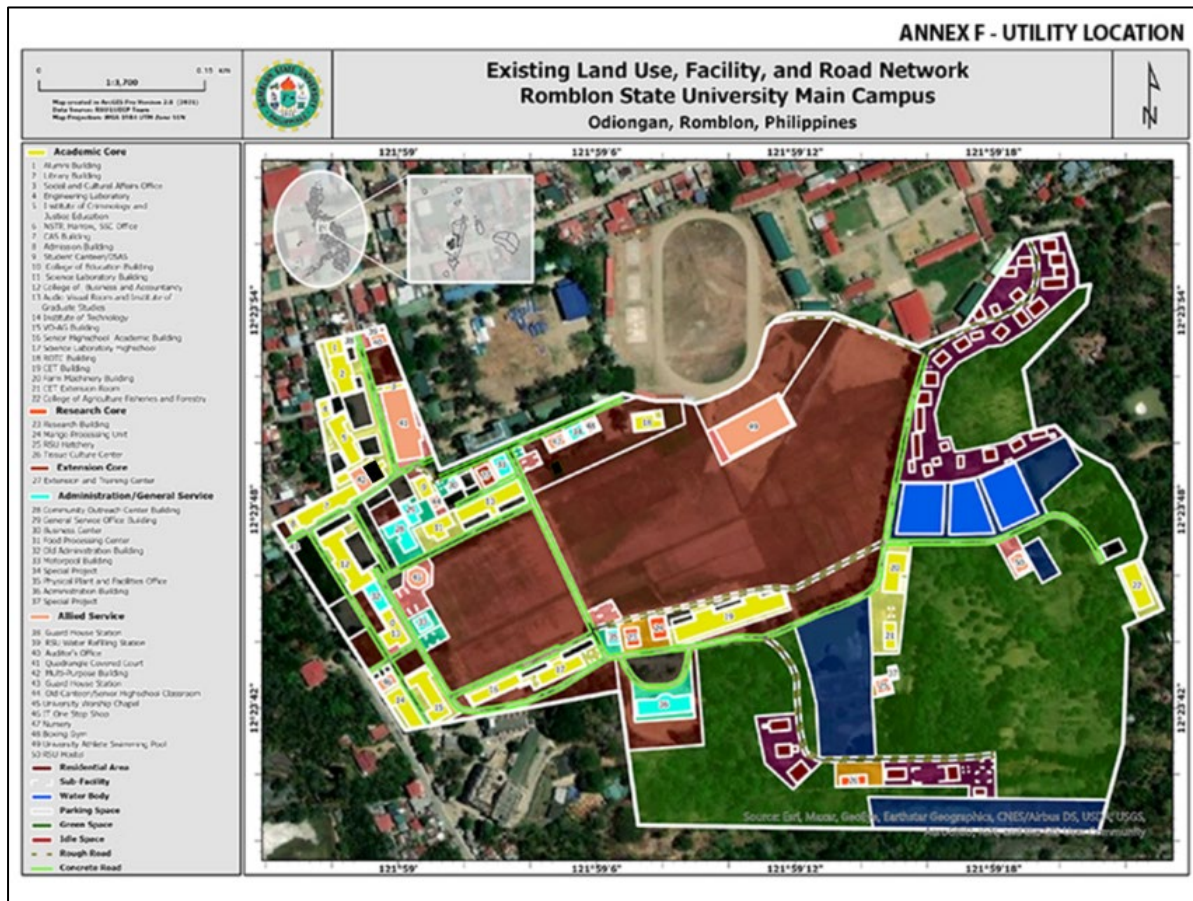

Figure: Existing Road Network of Rombon State University - Main Campus  
Source: Planning and Development Office



## **ANNEX G - PROPOSED DESIGN AND CONSTRUCTION SCHEDULE**



## **ANNEX H – MINIMUM REQUIREMENTS FOR A CONSTRUCTION SAFETY AND HEALTH PROGRAM**



## PROPOSED CONSTRUCTION OF LEARNING RESOURCE CENTER, PHASE 2

RSU-MAIN CAMPUS

1. The DESIGNER – BUILDER, shall undertake specific safety policies to observe and maintain its construction site, including the frequency and persons responsible for conducting toolbox and gang meetings.
2. The DESIGNER – BUILDER shall ensure that the Construction Safety and Health Program is executed and verified by the Construction Project Manager. The contractor must submit the said program to the **Bureau of Working Conditions (BWC)**, which may approve, disapprove or modify the same according to existing laws, rules, regulation, and other issues by the DOLE.
3. The DESIGNER – BUILDER shall include the cost of implementing the Construction Safety and Health Program and integrate it into the project’s construction cost. The said cost shall be a separate pay item, duly quantified and stated in the project’s tender and construction contract documents.
4. The DESIGNER – BUILDER shall provide adequate and approved types of protective equipment. Work within the construction project site shall be required to always wear the necessary Personal Protective Equipment (PPE). The DESIGNER – BUILDER shall see to it that:
  - The construction workers working from unguarded surfaces six (6) meters or more above water or ground, temporary or permanent floor platform, scaffold, or where they are exposed to the possibility of falls hazardous to life or limb, must be provided with the safety harness and lifelines.
  - Specialty construction workers must be provided with special protective equipment, such as goggles or respirators for welders and painters or paint applicators.
  - All persons authorized or allowed to be at a construction site shall wear appropriate PPE.
5. The DESIGNER – BUILDER must provide for a full – time officer, who shall be assigned as the general construction safety and health officer to oversee the overall management of the Construction Safety and Health Program. The general construction safety and health perform the following duties:
  - Frequently monitor and inspect any health and safety aspects of the construction work.
  - Assist government inspector in conducting safety and health inspection whenever work is being performed or during the accident investigation.
6. The DESIGNER – BUILDER must provide one (1) Construction Safety and Health Officer for every ten (10) units of heavy equipment assigned to the project site. This program will ensure effective compliance with the Construction Safety and Health Program regarding heavy utilization and maintenance at the construction project site.





**PROPOSED CONSTRUCTION OF LEARNING RESOURCE CENTER, PHASE 2**  
RSU-MAIN CAMPUS