





FIRE PROTECTIO
MECHANICAL PL

LEGEND:

-  - FIRE ALARM DETECTOR
-  - CCTV
-  - EMERGENCY LIGHT TWIN HEAD
-  - FIRE EXTINGUISHER

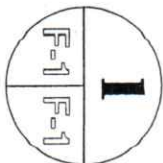

1
**GROUND FLOOR CCTV/EMERGENCY LIGHT/
F.D./FIRE EXTINGUISHER LAYOUT PLAN**

NTS.

PREPARED BY: ROMBLON STATE UNIVERSITY OFFICE OF PHYSICAL PLANT AND FACILITIES	MECHANICAL ENGINEER: <i>Moses B. Madate Jr.</i> Validity: 03/20/21 PRC REG. NO.: 016 2371 PIR NO.: 257497X UIC: 1-05-22-0 TIN: 10-17-8170 Place: Palawan Ave	CHECKED BY: <i>Jason F. Robson</i> APPROVED BY: <i>Jason F. Robson</i> MR. JASON F. ROBSON, M.A.S.H.P. D. CISE	PROJECT TITLE: REHABILITATION AND FURNISHING OF OLD/EXISTING UNIVERSITY BUILDING LOCATION: ROMBLON STATE UNIVERSITY - Main Campus, Living, Gateways, Romblon
SHEET CONTAINS: LOCATION OF CCTV, EMERGENCY LIGHT, FDE AND FIRE EXTINGUISHER		PREPARED BY: CAD OPERATOR: BSCS / SIM	DATE:
			

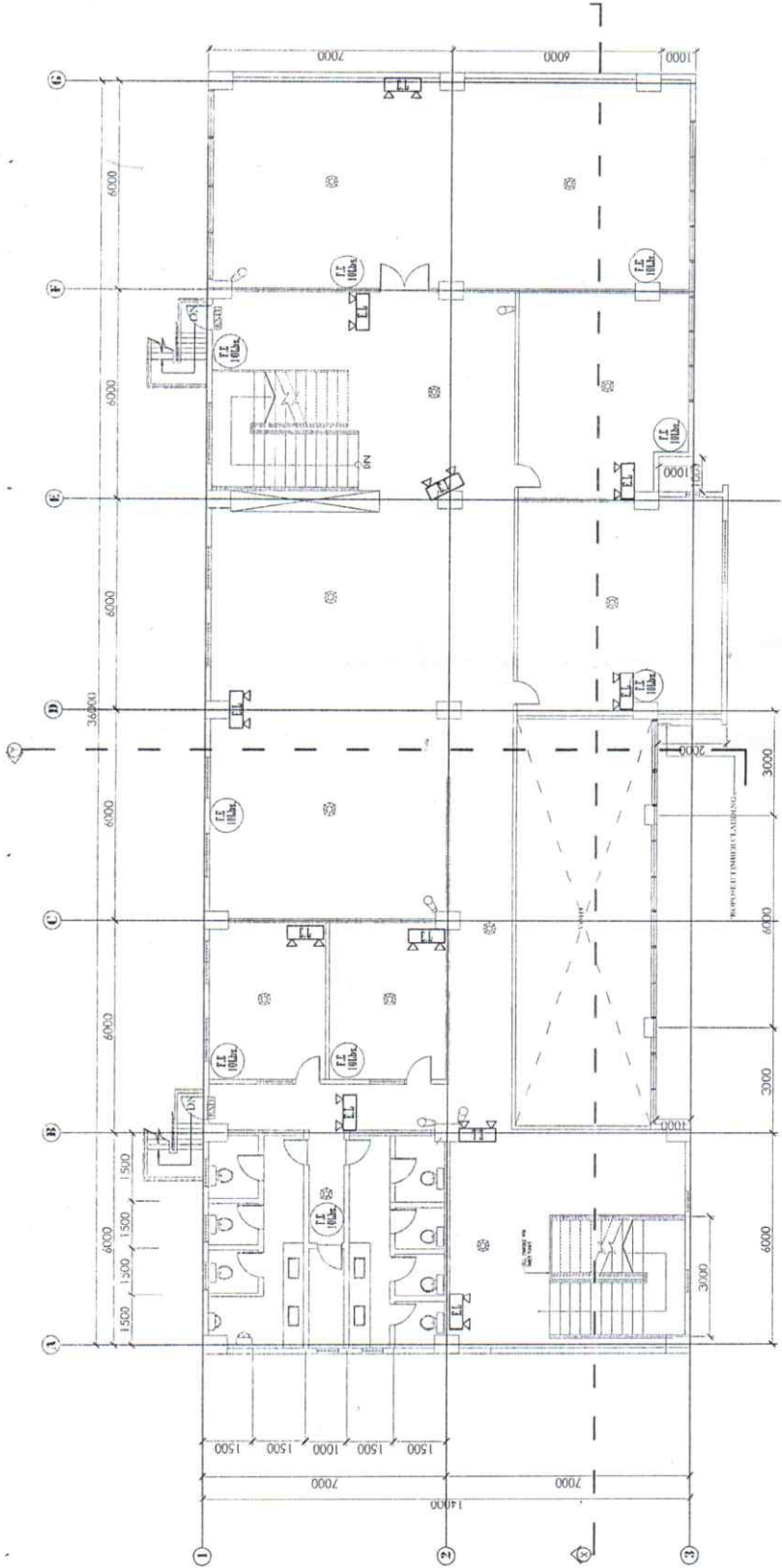

SECOND FLOOR CCTV/EMERGENCY LIGHT/ F.D.E./FIRE EXTINGUISHER LAYOUT PLAN

NTS.



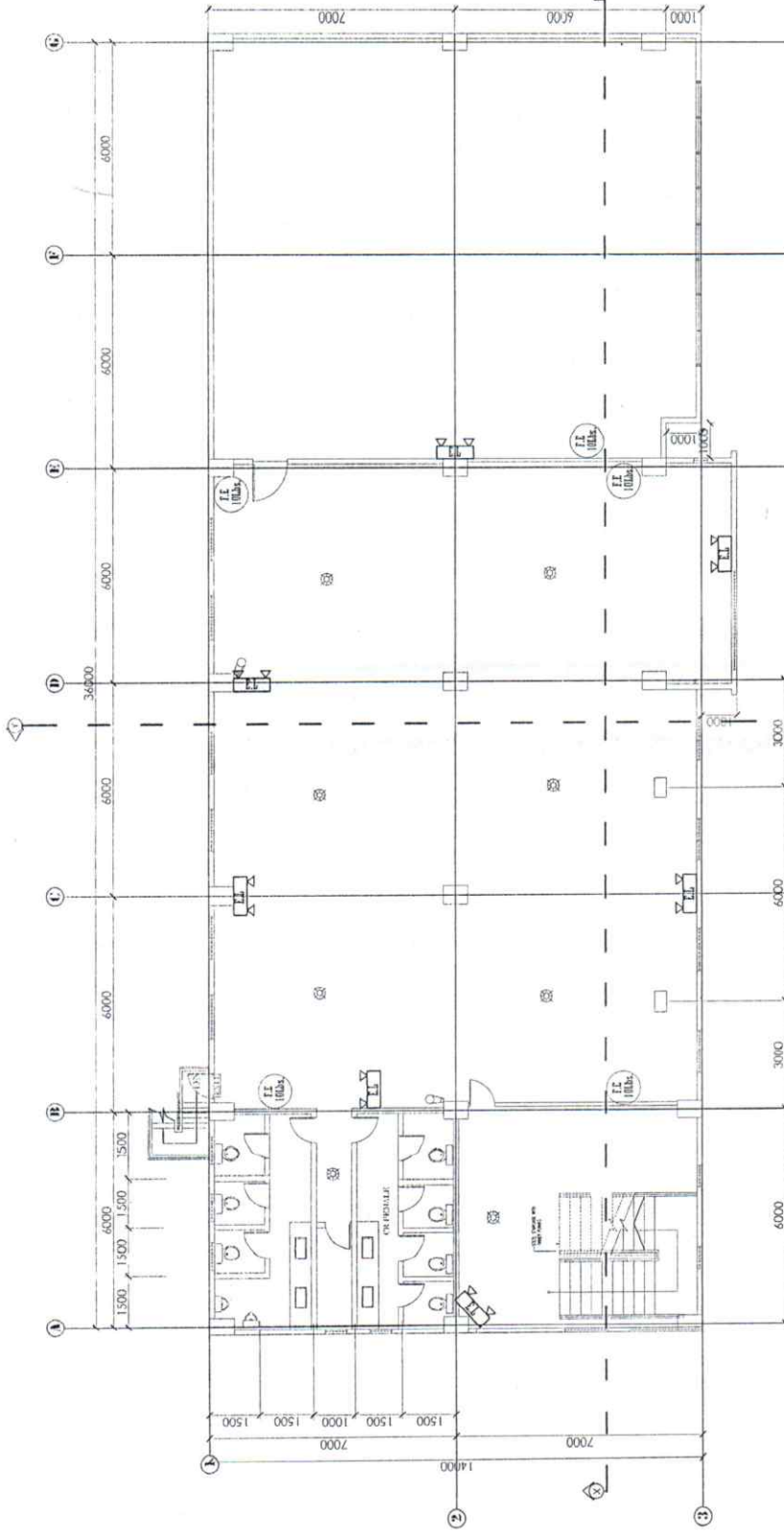

1
 F-2 F-2

- LEGEND:**
- ⊗
- FIRE ALARM DETECTOR
 - 📷
- CCTV
 - E.L.
- EMERGENCY LIGHT TWIN HEAD
 - F.E. 10Lbs.
- FIRE EXTINGUISHER

PREPARED BY:	MECHANICAL ENGINEER:	CHECKED BY:	PROJECT TITLE:
ROMBLON STATE UNIVERSITY	<i>Maria B. MADRUTE JR</i>	<i>Maria B. MADRUTE JR</i>	REHABILITATION AND FURNISHING OF OLD/EXISTING UNIVERSITY BUILDING
OFFICE OF PHYSICAL PLANT AND FACILITIES	PRC REG. No. : PTR No. : Face:	Validity : Date : TIN :	SHEET CONTENT: LOCATION OF CCTV, EMERGENCY LIGHT, FDE AND FIRE EXTINGUISHER
			PREPARED BY: CAD OPERATOR: BOCC / SJM JOB NO. : DATE :
			F-2
			LOCATION : ROMBLON STATE UNIVERSITY - Main Campus, Linaoang, Abuyog, Romblon



LEGEND:

-  - FIRE ALARM DETECTOR
-  - CCTV
-  - EMERGENCY LIGHT TWIN HEAD
-  - FIRE EXTINGUISHER

THIRD FLOOR CCTV/EMERGENCY LIGHT/ F.D.E./FIRE EXTINGUISHER LAYOUT PLAN

NTS.

I
 F-3 F-3

PREPARED BY: ROMBLON STATE UNIVERSITY OFFICE OF PHYSICAL PLANT AND FACILITIES	CHECKED BY: <i>[Signature]</i> JASON P. REASON PHYS. DIRECTOR	PROJECT TITLE: REHABILITATION AND FURNISHING OF OLD/EXISTING UNIVERSITY BUILDING	SHEET CONTENT: LOCATION OF CCTV, EMERGENCY LIGHT, FDE AND FIRE EXTINGUISHER
MECHANICAL ENGINEER <i>Moses B. Moore Jr.</i> PRC REG. No. : URB: : TIN :	APPROVED BY: <i>[Signature]</i> MERIAN CATANAN-MAÑELED, CESE RST Professor	PREPARED BY: CAD OPERATOR: BSCS / SLM JOB NO. : DATE :	<div style="border: 1px solid black; border-radius: 50%; width: 40px; height: 40px; margin: 0 auto; display: flex; align-items: center; justify-content: center;"> F-3 </div>

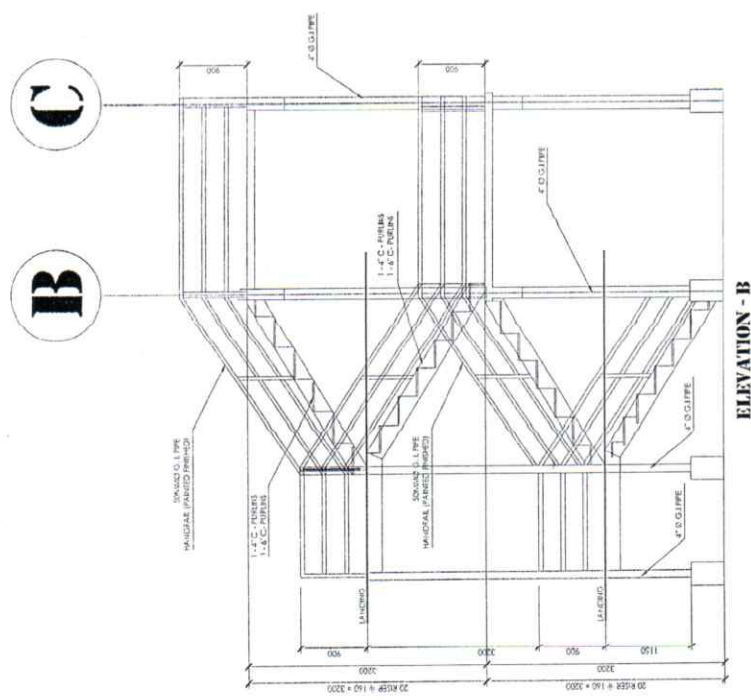

ELEVATION - B

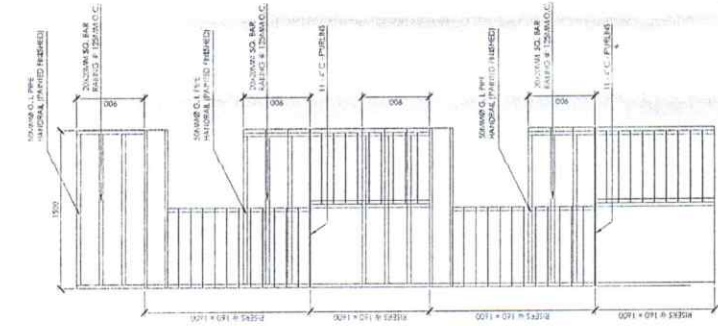

ELEVATION - A



SECOND FLOOR PLAN

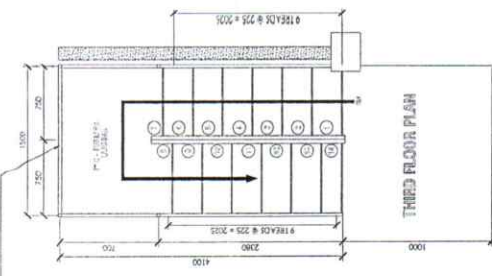

THIRD FLOOR PLAN

1 FIRE ESCAPE ELEVATION PLAN

1:50

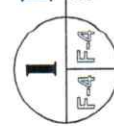

2 FIRE ESCAPE PLAN

1:50



PREPARED BY: ROMBLON STATE UNIVERSITY OFFICE OF PHYSICAL PLANT AND FACILITIES	CIVIL ENGINEER <i>Mages B. Magante Jr.</i> MAGES B. MAGANTE JR. Validity: _____ Date: _____ Place: _____ TIN: _____	CHECKED BY: JASON P. BERNON JASON P. BERNON PPD-Observer	PROJECT TITLE: REHABILITATION AND FURNISHING OF OLD/EXISTING UNIVERSITY BUILDING LOCATION - ROMBLON STATE UNIVERSITY - Main Campus, Liradang, Odongpan, Romblon	SHEET CONTENT: FIRE ESCAPE ELEVATION FIRE EXIT PLAN	REPERED BY: CAD OPERATOR: BCSC / SIM JOB NO.: DATE:	
	PREPARED BY: ROMBLON STATE UNIVERSITY OFFICE OF PHYSICAL PLANT AND FACILITIES	CIVIL ENGINEER <i>Mages B. Magante Jr.</i> MAGES B. MAGANTE JR. Validity: _____ Date: _____ Place: _____ TIN: _____	CHECKED BY: JASON P. BERNON JASON P. BERNON PPD-Observer	PROJECT TITLE: REHABILITATION AND FURNISHING OF OLD/EXISTING UNIVERSITY BUILDING LOCATION - ROMBLON STATE UNIVERSITY - Main Campus, Liradang, Odongpan, Romblon	SHEET CONTENT: FIRE ESCAPE ELEVATION FIRE EXIT PLAN	

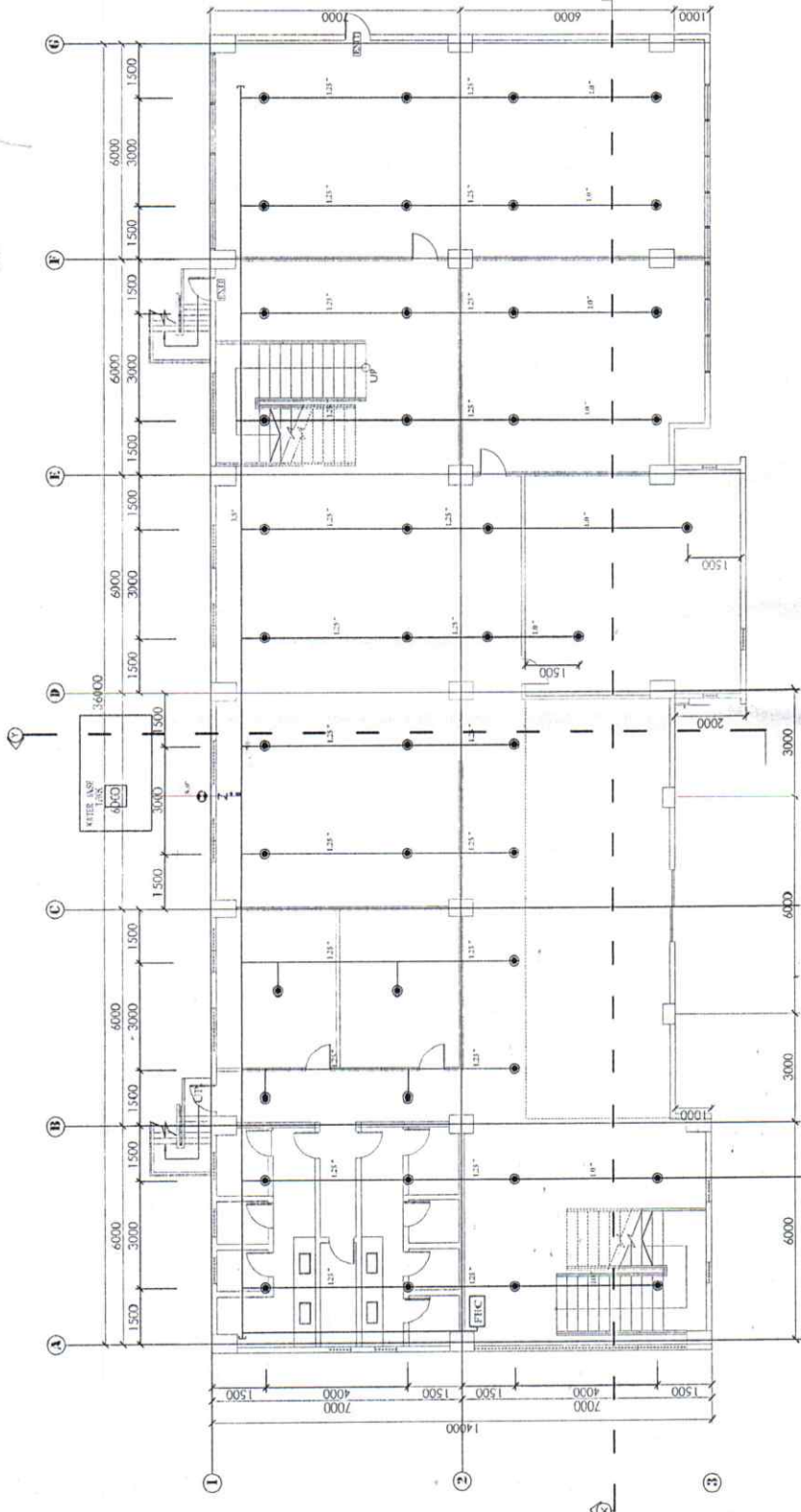

1 GROUND FLOOR SPRINKLING LAYOUT PLAN
 1:100
F-5 SCALE

LEGEND:

T	END CAP
●	SPRINKLER HEAD
○	PENDENT TYPE
●	RISER PIPE

PREPARED BY: ROMBLON STATE UNIVERSITY OFFICE OF PHYSICAL PLANT AND FACILITIES	MECHANICAL ENGINEER: Mages B. SORAGATE JR. PRC REG. No. : PIRING : Place :	CHECKED BY: JASON S. SAMPSON PRC REG. No. : APPROVED BY: MERIAN PATAYAMAMANI P.A.D., C.E. RSI President	PROJECT TITLE: REHABILITATION AND FURNISHING OF OLD/EXISTING UNIVERSITY BUILDING LOCATION : ROMBLON STATE UNIVERSITY - Main Campus, Liranga, Odjogan, Romblon	SHEET CONTENT: AS SHOWN	PREPARED BY: CAD OPERATOR:	F-5
					BSCS / SEM JOB NO. : DATE :	

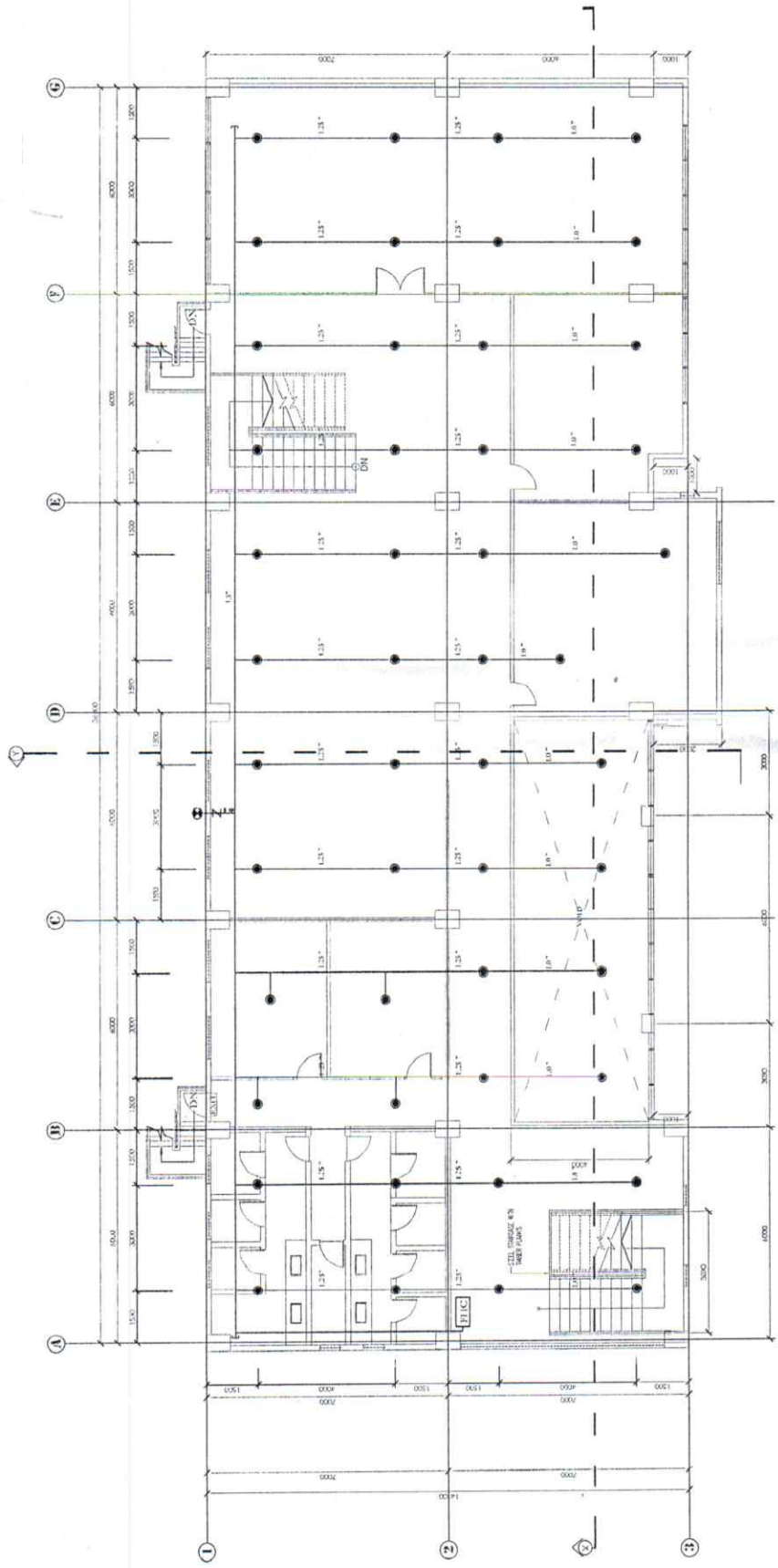

I SECOND FLOOR SPRINKLING LAYOUT PLAN
 SCALE 1:100

LEGEND:

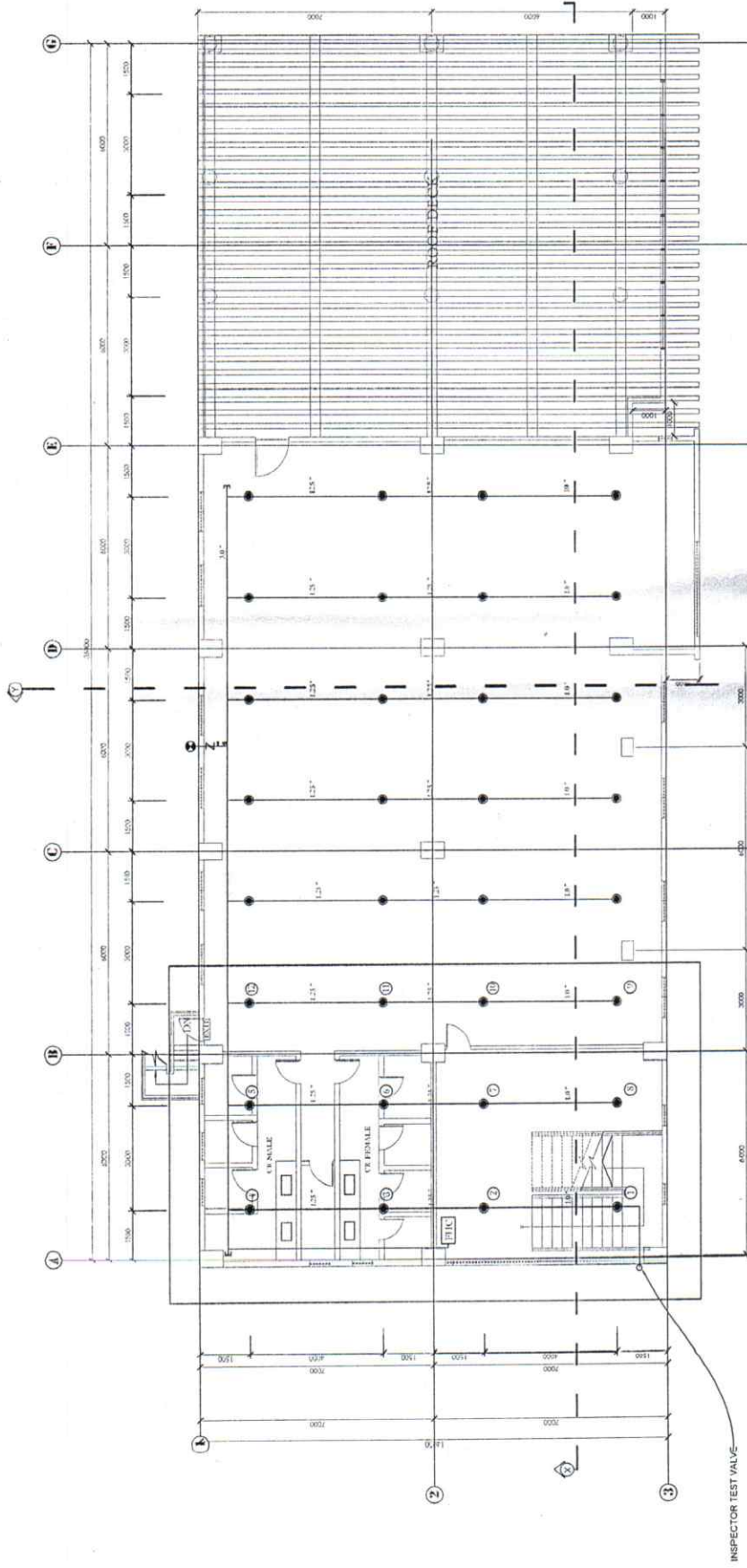

- T END-CAP
- SPRINKLER HEAD
- PENDENT TYPE
- RISER PIPE

PREPARED BY: ROMBLON STATE UNIVERSITY OFFICE OF PHYSICAL PLANT AND FACILITIES	MECHANICAL ENGINEER: <i>MORDES B. MABATE JR</i> Validity: _____ Date: _____ TIN: _____ PRC REG. NO.: _____ PRC REG. NO.: _____ PRC REG. NO.: _____	CHECKED BY: <i>MORDES B. MABATE JR</i> LASONALISON PPECO-Engr APPROVED BY: <i>[Signature]</i> MERRIANE CATAYAMAN, Ed.D., CFSE RSN, President	PROJECT TITLE: REHABILITATION AND FURNISHING OF OLD/EXISTING UNIVERSITY BUILDING LOCATION: ROMBLON STATE UNIVERSITY - Main Campus, Juvang, Galingan, Romblon
SHEET CONTENT: AS SHOWN		PREPARED BY: CAD OPERATOR: BCSC / SLM JOB NO.: DATE:	
<div style="border: 1px solid black; border-radius: 50%; width: 40px; height: 40px; display: flex; align-items: center; justify-content: center; margin: 0 auto;"> F-6 </div>			

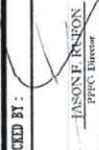

I THIRD FLOOR SPRINKLING LAYOUT PLAN
 1:100

LEGEND:
 T END CAP
 ● SPRINKLER HEAD
 ◼ PENDANT TYPE
 ● RISER PIPE

MECHANICAL ENGINEER ROMBLON STATE UNIVERSITY OFFICE OF PHYSICAL PLANT AND FACILITIES	CHECKED BY:  HASONO RINON PPGC License	PROJECT TITLE: REHABILITATION AND FURNISHING OF OLD/EXISTING UNIVERSITY BUILDING	PREPARED BY: CAD OPERATOR: BCSC / SIM JOB NO. : DATE :
	MECHANICAL ENGINEER MARYS / B. MARORE JR. Validity : Date : TIN :	APPROVED BY:  MERHAN P. CATURAY-MANSI Ed. D. C. ESE PSU Professor	SHEET CONTENT: AS SHOWN

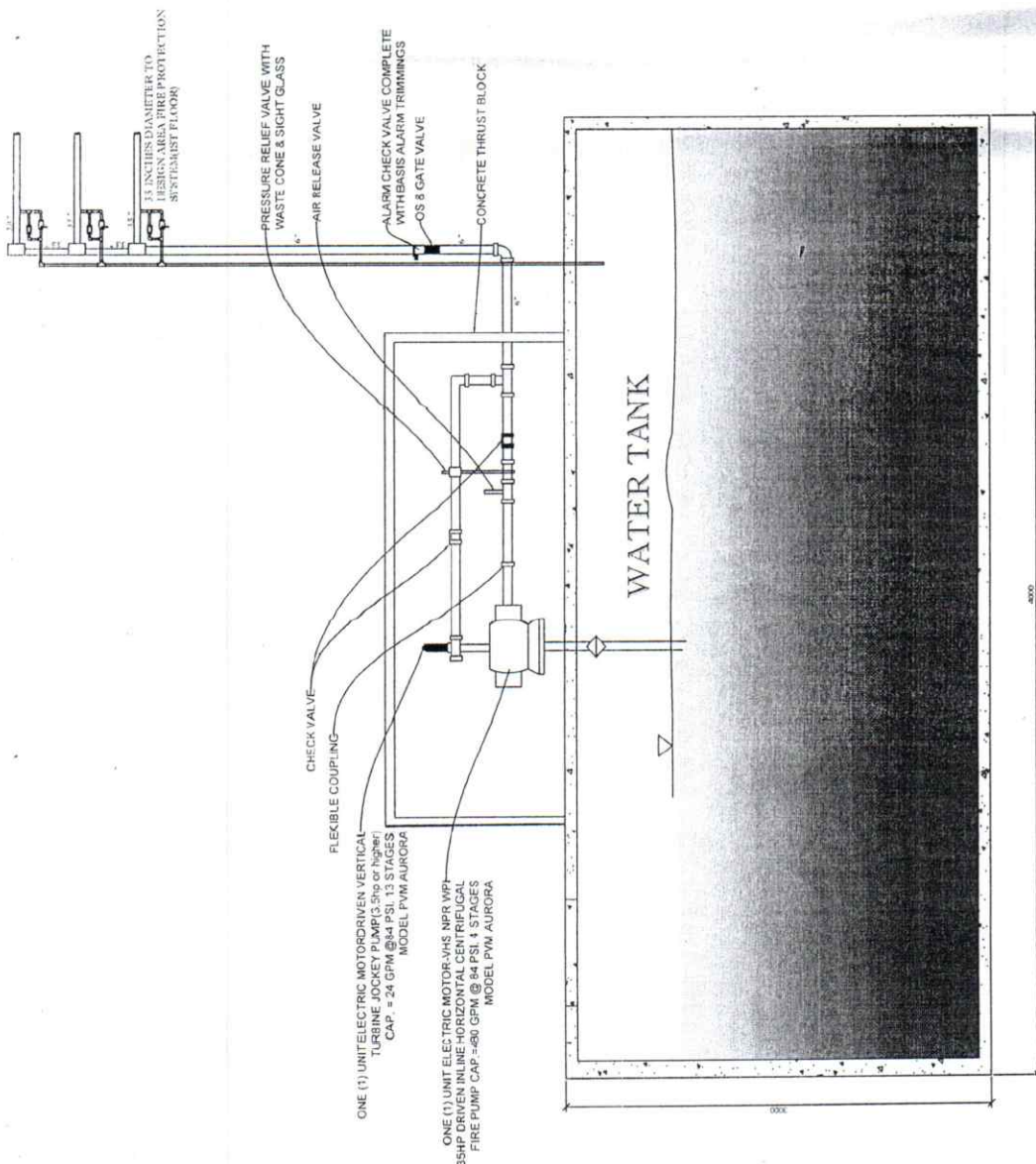

1 PUMP ROOM DETAIL AND INSTALLATION
 NTS
 F-8 F-8 SCALE

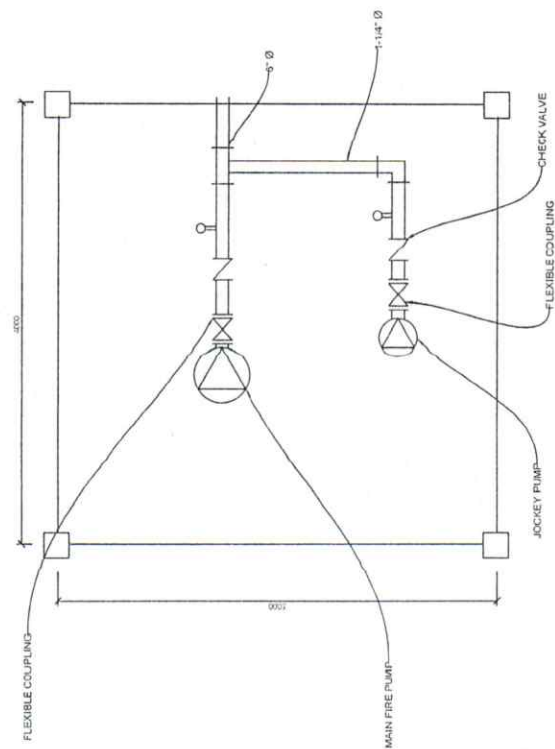

2 PUMP HOUSE ASSEMBLY
 F-8 F-8 SCALE

PREPARED BY: ROMBLON STATE UNIVERSITY OFFICE OF PHYSICAL PLANT AND FACILITIES	MECHANICAL ENGINEER <i>Moses B. Maturate, R.</i> Validity: _____ Date: _____ TIN: _____	CHECKED BY: HANSON E. RUFON UPPLD, Director APPROVED BY: <i>MIRBANT S. SUTAWAN, MANI Ed.D., CSE</i> JSAI, President	PROJECT TITLE: REHABILITATION AND FURNISHING OF OLD/EXISTING UNIVERSITY BUILDING	SHEET CONTENT: AS SHOWN	PREPARED BY: CAD OPERATOR: BCSC / SLM JOB NO.: DATE:
			F-8		

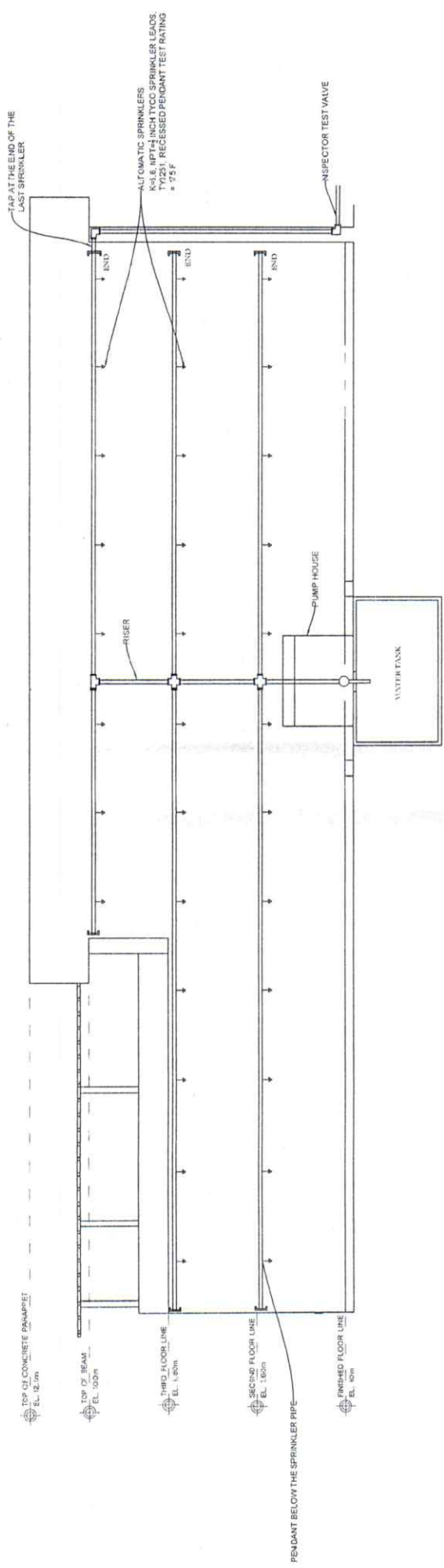

1 PIPING LAYOUT
SCALE 1:100

LEGEND:

	90 DEGREE TURN ELBOW
	TEE
	BUTTERFLY VALVE
	FLOW SWITCH
	ALARM CHECK VALVE
	INSPECTOR TEST VALVE
	SIGHT GLASS
	OS & Y VALVE
	RISER NIPPLE
	PRESSURE GAUGE
	STRAINER

PREPARED BY:	<i>Wulany</i>	MECHANICAL ENGINEER	PROJECT TITLE:	SHEET CONTENT:	PREPARED BY:
			REHABILITATION AND FURNISHING OF OLD/EXISTING UNIVERSITY BUILDING	AS SHOWN	CAD OPERATOR:
					BCSC / SLM
					JOB NO.:
					DATE:
ROMBLON STATE UNIVERSITY		F-9			
OFFICE OF PHYSICAL PLANT AND FACILITIES		LOCATION: ROMBLON STATE UNIVERSITY - Main Campus, Linaoang, Odiganan, Romblon			
CECILED BY:		APPROVED BY:			
<i>JASON F. RUFON</i> HYDRO-HEATING		<i>[Signature]</i> MECHANICAL ENGINEER			
PPRC REG. No.:	Validity:				
PTR NO.:	Date:				
Place:	TIN:				

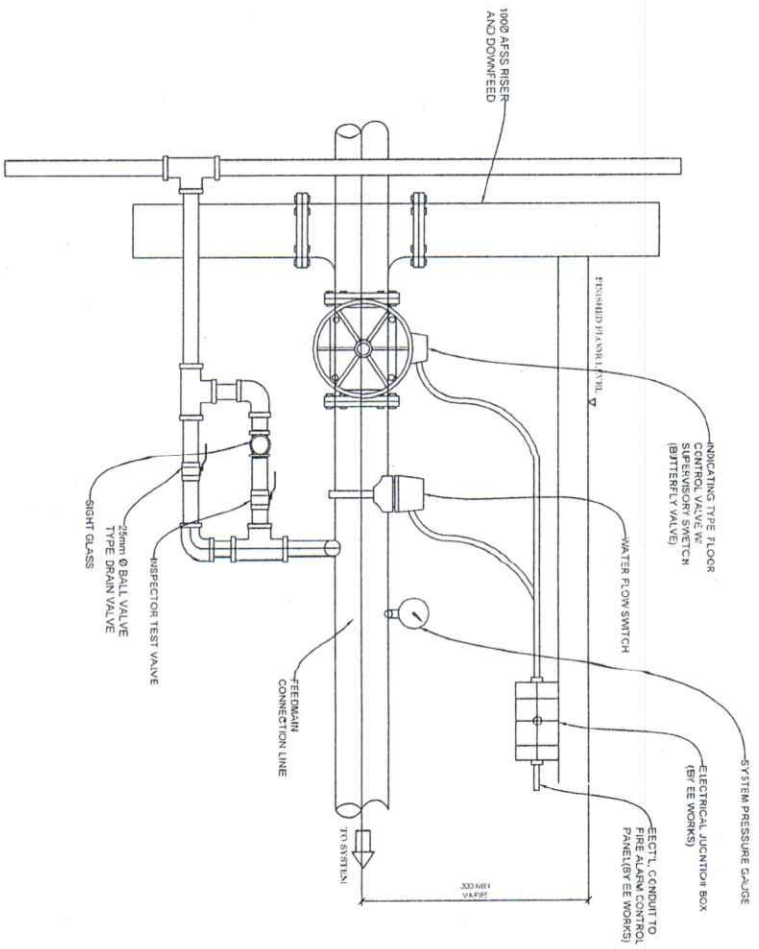

1 FLOOR CONTROL VALVE ASSEMBLY

F-10 F-10

NTS.

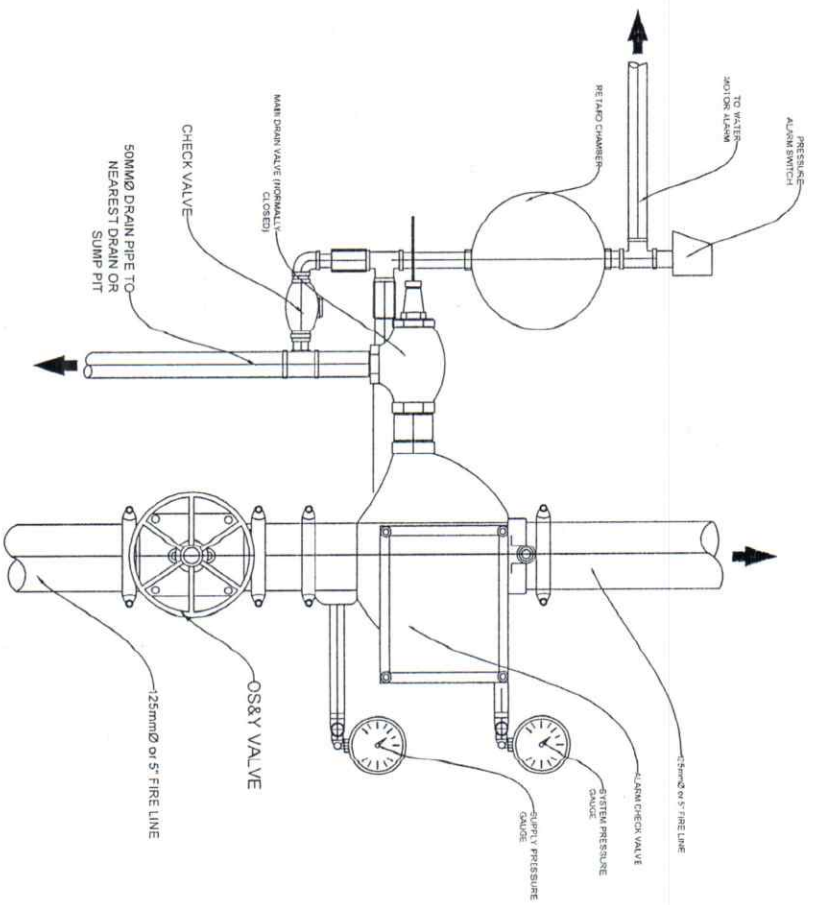

2 ALARM CHECK VALVE ASSEMBLY

F-10 F-10

NTS.

PREPARED BY:	CHECKED BY:
--------------	-------------

ROMELAN STATE UNIVERSITY

Moses K. mabait Jr.

DANSON F. RUPIN
Project Engineer

OFFICE OF PHYSICAL PLANT AND FACILITIES

PROJ REG. NO.:	Validity:	APPROVED BY:
PTIR NO.:	DATE:	MERLON F. AYDIA-MANUEL D. GISE Asst. President
Place:	TIN:	

PROJECT TITLE:

REHABILITATION AND FURNISHING OF OLD/EXISTING UNIVERSITY BUILDING

LOCATION: ROMELAN STATE UNIVERSITY - Main Campus, Linaang, Davao, Mindanao, Philippines

SHEET CONTENT:

AS SHOWN

PREPARED BY:

CAD OPERATOR:

BGSC / SLM

JOB NO.:

DATE:

F-10

TABLE OF DIMENSION

PIPE SIZE	DIMENSION IN MILLIMETER (MM)			
	ROD DA.	B	C	F (MAX)
50	10	110	140	22
65/80	12	125	163	30
100	16	155	240	50
150	19	180	255	50

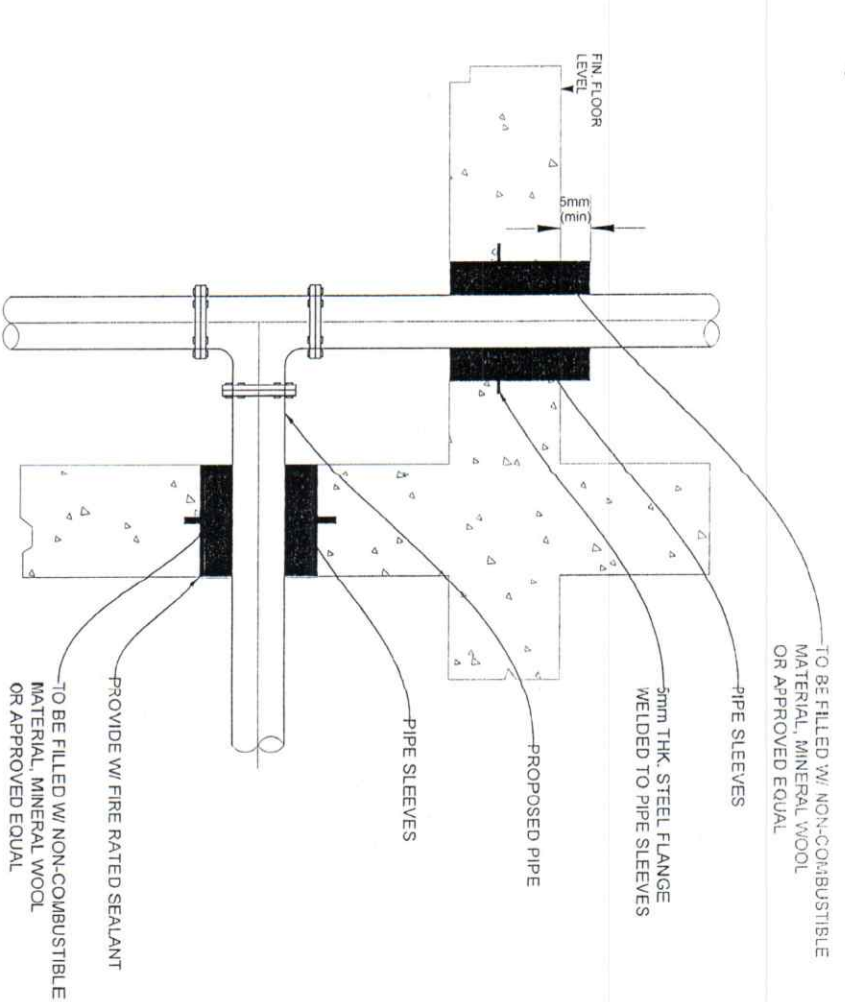
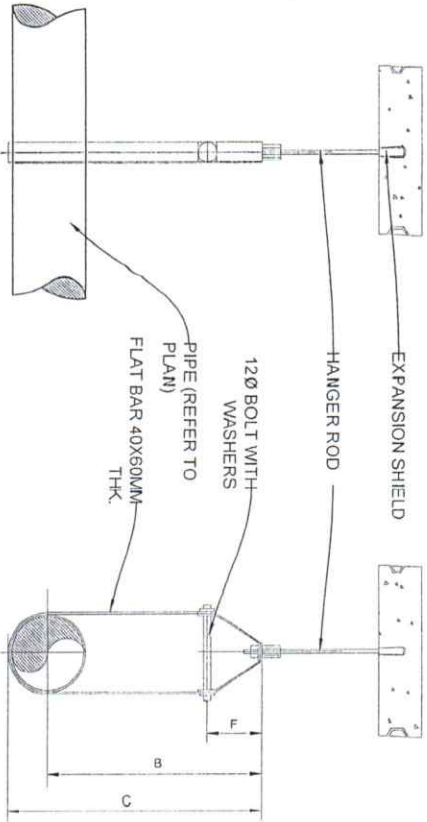

SCHEDULE OF PIPE SLEEVES

SIZE OF BRANCHLINES	SIZE OF PIPE SLEEVES
25MM	50MM
32MM	50MM
40MM	65MM
50MM	75MM
65MM	100MM
75MM	100MM
100MM	150MM
150MM	225MM
200MM	300MM

NOTE:
SLEEVES SHALL BE PROVIDED AROUND ALL PIPING EXTENDING THROUGH WALLS, FLOORS, PLATFORMS AND FOUNDATIONS

1. THE CLEARANCE BETWEEN THE PIPE SLEEVES SHALL BE FILLED W/NON-COMBUSTIBLE FLEXIBLE MATERIAL SUCH AS MINERAL WOOL, FIBER GLASS OR EQUIVALENT.
2. MINIMUM CLEARANCE BETWEEN PIPE AND SLEEVES SHALL NOT BE LESS THAN 25MM FOR PPE 25MM THROUGH 75MM & 40MM FOR PPE SIZE 100MM AND LARGER FLOOR SLEEVES SHALL BE EXTENDED AT LEAST 75MM ABOVE THE TOP OF THE WEARING SURFACE.

1 PIPE HANGER DETAILS

F-11 F-11

NTS.

2 PIPE SLEEVES DETAILS

F-11 F-11

NTS.

PREPARED BY :

ROMBION STATE UNIVERSITY

OFFICE OF PHYSICAL PLANT AND FACILITIES

MECHANICAL ENGINEER

Notes / B. in RESERVE Jy.

CHECKED BY :

APPROVED BY:

PROJECT TITLE :

REHABILITATION AND FURNISHING OF OLD/EXISTING UNIVERSITY BUILDING

SHEET CONTENT:

AS SHOWN

PREPARED BY :

CAD OPERATOR:

BCSC / SLM

DATE :

JOB NO. :

F-11

LOCATION : ROMBION STATE UNIVERSITY - Main Campus, Lingsang, Olongana, Bantayan

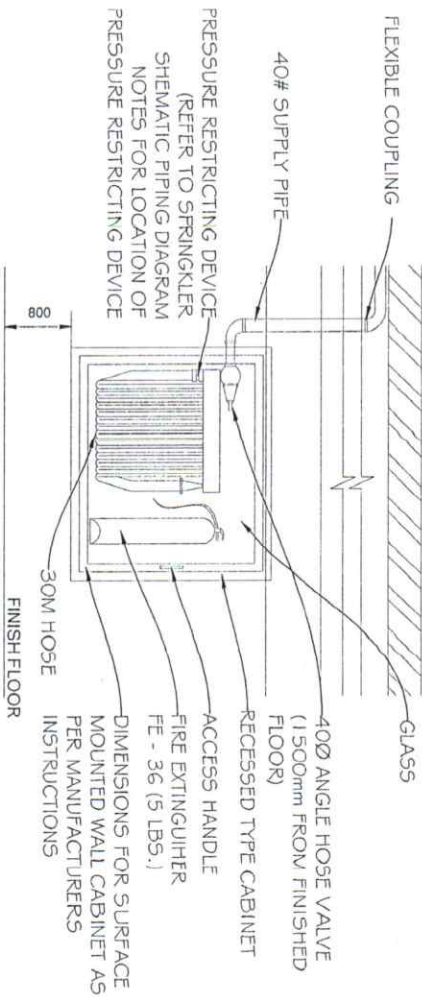
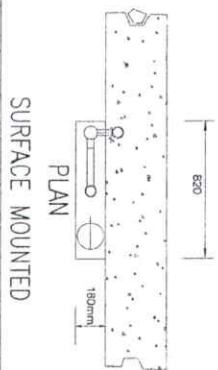
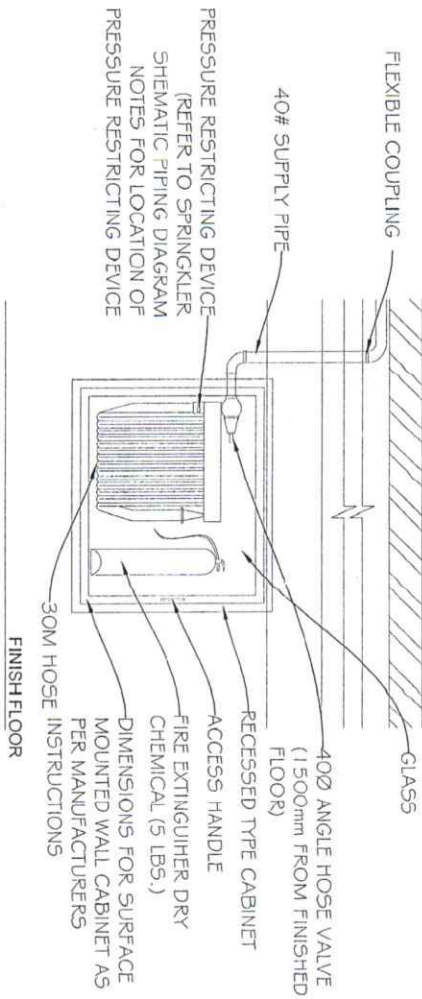
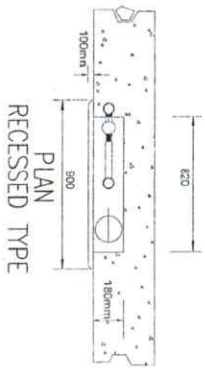

F-12 F-12

1 FIRE HOSE CABINET DETAILS

NTS.

REFERRED BY: ROMBLON STATE UNIVERSITY OFFICE OF PHYSICAL PLANT AND FACILITIES	MECHANICAL ENGINEER <i>[Signature]</i> No 065 / B. 210344E JIA	CHECKED BY: TONYSON F. ALFONSO TONYSON F. ALFONSO	PROJECT TITLE: REHABILITATION AND FURNISHING OF OLD/EXISTING UNIVERSITY BUILDING LOCATION: ROMBLON STATE UNIVERSITY - Main Campus, Libingan, Odongpan, Romblon	SHEET CONTENT: AS SHOWN	PREPARED BY: CAD OPERATOR: BSCG / SLM JOB NO.: DATE:	<div style="border: 1px solid black; border-radius: 50%; width: 40px; height: 40px; display: flex; align-items: center; justify-content: center; margin: 0 auto;"> F-12 </div>
--	--	---	---	----------------------------	--	--

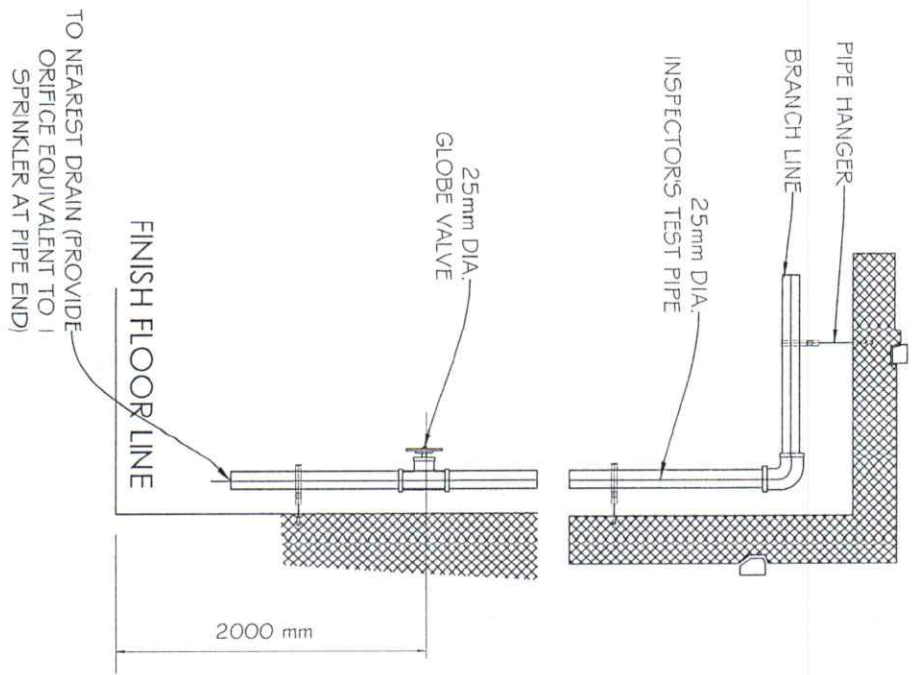
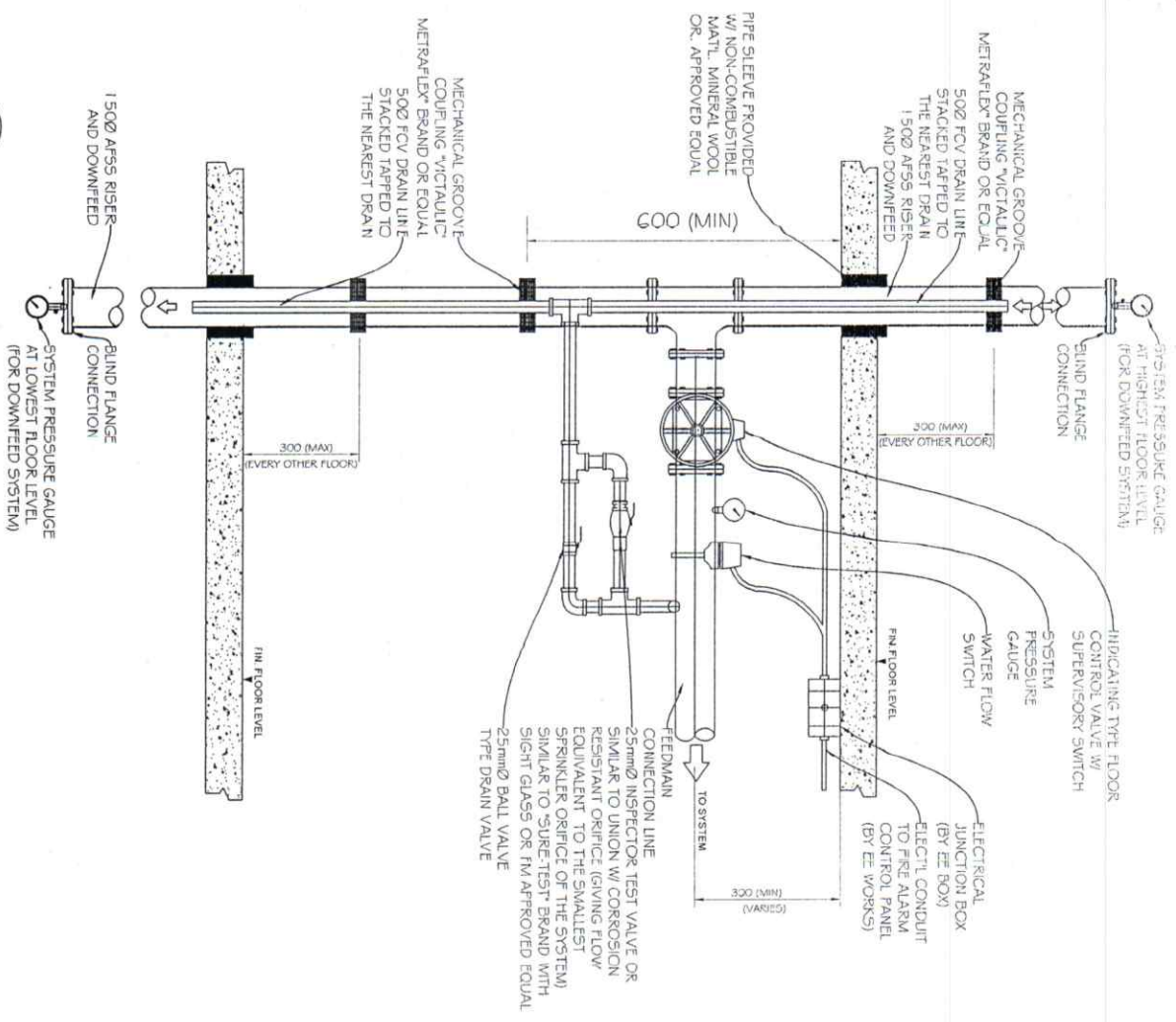

1 FLOOR CONTROL VALVE ASSEMBLY DETAILS

F-13/F-13

NTS

PREPARED BY: ROMBON STATE UNIVERSITY	MECHANICAL ENGINEER <i>[Signature]</i>	CHECKED BY: <i>[Signature]</i>	PROJECT TITLE: REHABILITATION AND FURNISHING OF OLD/EXISTING UNIVERSITY BUILDING	SHEET CONTENT: AS SHOWN	PREPARED BY: CAD OPERATOR: EASC / SLM JOB NO. : DATE :
OFFICE OF PHYSICAL PLANT AND FACILITIES	PRG REG. No. : <i>Mages B. Mabure Jr.</i>	APPROVED BY: <i>[Signature]</i> NERBAN H. CATALAN, M.A.S., M.I.E.D., C.S.E. Est. Professor	LOCATION: ROMBON STATE UNIVERSITY - Main Campus, Iliana, Gingoog, Zamboanga	FTR NO. : DATE : TIN :	F-13

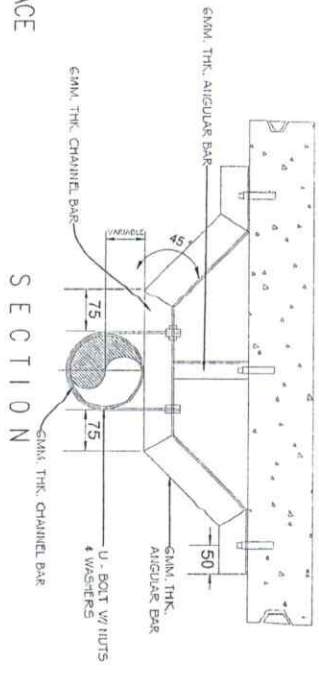
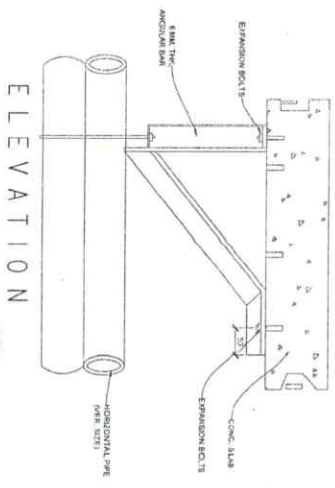
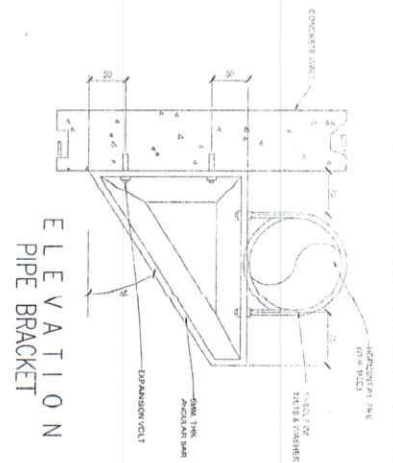
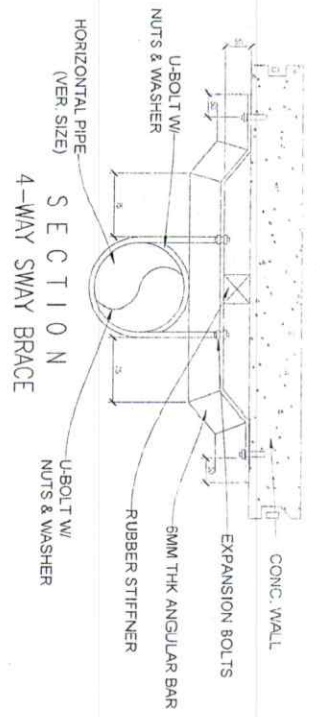

1 DETAILS OF SWAY BRACINGS

F-14, F-15

NTS.

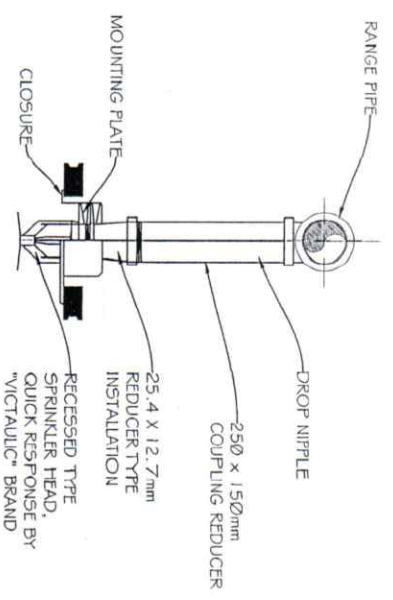
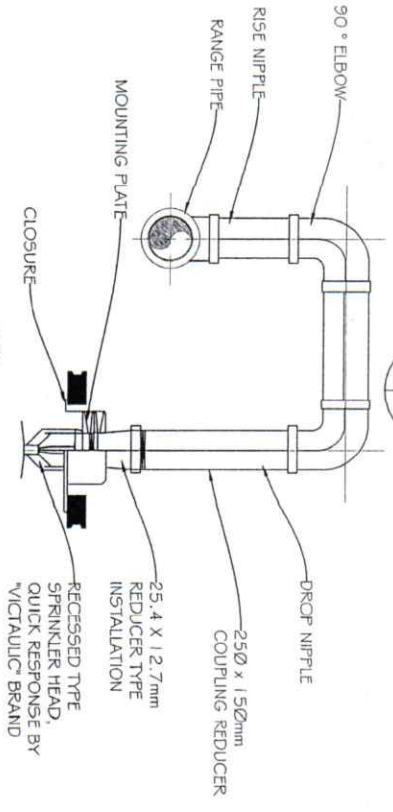

2 PENDENT SPRINKLER HEAD DETAILS

F-14, F-16

NTS.

PREPARED BY: *[Signature]* CHECKED BY: *[Signature]* SHEET CONTENT: **AS SHOWN** PREPARED BY: **CAD OPERATOR:**

ROMBION STATE UNIVERSITY

OFFICE OF PHYSICAL PLANT AND FACILITIES

MECHANICAL ENGINEER

PROV. DESIGNER

REHABILITATION AND FURNISHING OF OLD/EXISTING UNIVERSITY BUILDING

BCSC / SLM

PROJ. REG. NO.: *10975 / R. MABUIT JR.*

DATE: *[Blank]*

LOCATION: ROMBION STATE UNIVERSITY - Main Campus, Linaang, Odongon, Marikina

DATE: *[Blank]*

F-14