







1 GROUND FLOOR WATER LAYOUT PLAN
 P-4 / P-4 / SCALE
 1:150

2 SECOND FLOOR WATER LAYOUT PLAN
 P-4 / P-4 / SCALE
 1:150

3 THIRD FLOOR WATER LAYOUT PLAN
 P-4 / P-4 / SCALE
 1:150

PREPARED BY : KOMBOM STATE UNIVERSITY OFFICE OF PHYSICAL PLANT AND FACILITIES		MASTER PLUMBER 		CHECKED BY : JANSON F. RIBBIN 		PROJECT TITLE : REHABILITATION AND FURNISHING OF OLD/EXISTING UNIVERSITY LIBRARY		SHEET CONTENT : AS SHOWN		PREPARED BY : CAD OPERATOR	
PRC REG. NO. : 		DATE : 		APPROVED BY : MARGENT P. DELAVALLE, JR. Ed.D. CSE 		LOCATION : KOMBOM STATE UNIVERSITY - Main Campus, Linaas, Olongapo, Zamboanga		BSCG / SLM JOB NO. :		DATE :	
PFR NO. : Place :		Date : TIN :		APPROVED BY : 		LOCATION : KOMBOM STATE UNIVERSITY - Main Campus, Linaas, Olongapo, Zamboanga		SHEET CONTENT : AS SHOWN		PREPARED BY : CAD OPERATOR	
P-4											

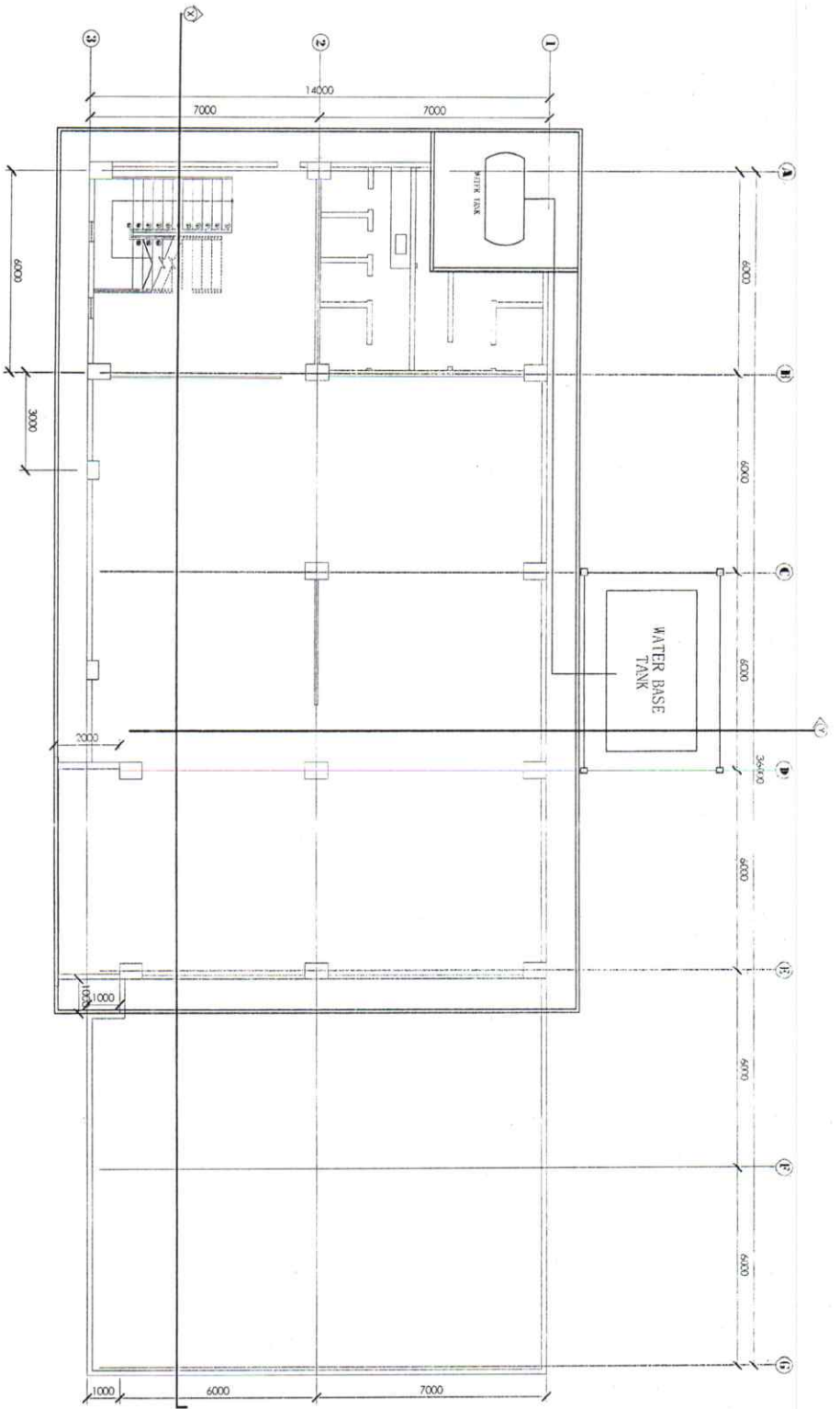

P-5 | **1** | **PLACEMENT OF WATER TANK**
 SCALE 1:150

PREPARED BY: ROMBION STATE UNIVERSITY OFFICE OF PHYSICAL PLANT AND FACILITIES	MASTER PIONEER CHECKED BY: JESSIE R. F. FONG ASSISTANT PHYSICAL PLANT ENGINEER	PROJECT TITLE: REHABILITATION AND FURNISHING OF OLD/EXISTING UNIVERSITY LIBRARY	SHEET CONTENT: AS SHOWN
PTR No.: Date: Place:	PRC REG. No.: ATTACHED BY: T.N.:	LOCATION: ROMBION STATE UNIVERSITY - Main Campus, Living, Odongog, Bantayan	PREPARED BY: BCSC / SLM JOB NO.: DATE:
P-5			

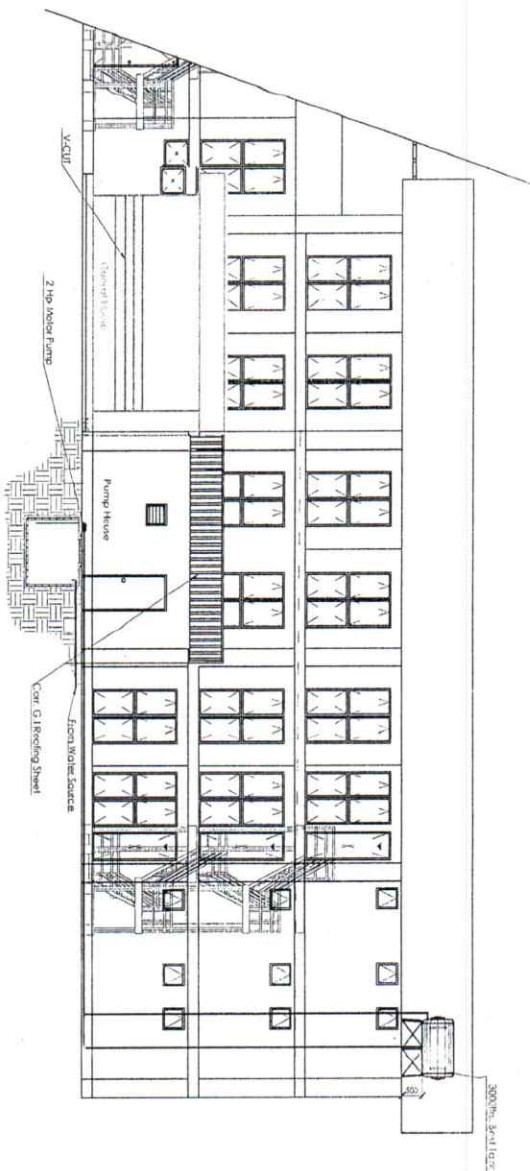

1 ELEVATION PLAN
SCALE 1:100

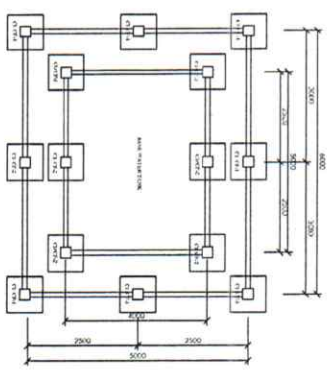

3 FOUNDATION PLAN
SCALE 1:100

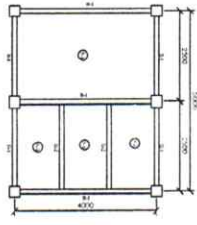

4 WATER BASE TANK SLAB PLAN
SCALE 1:100

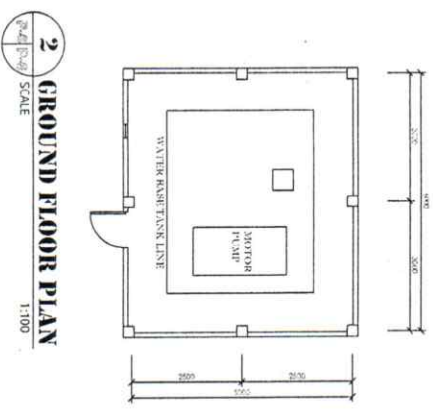

2 GROUND FLOOR PLAN
SCALE 1:100

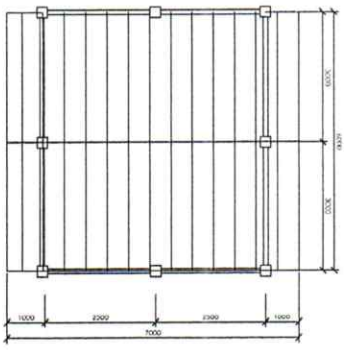

5 ROOF FRAMING PLAN (PUMP HOUSE)
SCALE 1:100

PREPARED BY: [Signature] PROJECT TITLE: **REHABILITATION AND FURNISHING OF OLD/EXISTING UNIVERSITY LIBRARY** SHEET CONTAINS: AS SHOWN PREPARED BY: CAD OPERATOR: BOSC / SLM DATE: [Blank]

ROMELTON STATE UNIVERSITY

OFFICE OF PHYSICAL PLANT AND FACILITIES

DESIGNED BY: [Signature] APPROVED BY: [Signature]

PROG. REG. NO. [Blank] ENGINEER'S SIGNATURE: [Signature] REGISTERED PROFESSIONAL ENGINEER

PROF. [Blank] ARCH. [Blank] CIVIL [Blank] ELECTRICAL [Blank] MECHANICAL [Blank] P.L.L.C. NO. [Blank] T.N. [Blank]

SHEKMAN P. STANISLAWSKI D. CSR

LOCATION: ROMELTON STATE UNIVERSITY - Main Campus, Lawasag, Odongon, Iloilo

P-6

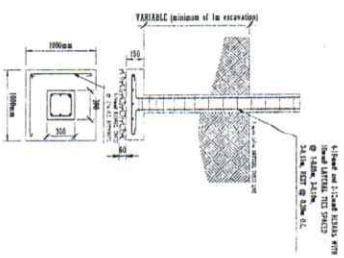

1 CI/CF1 & FOUNDATION PLAN
SCALE 1:30

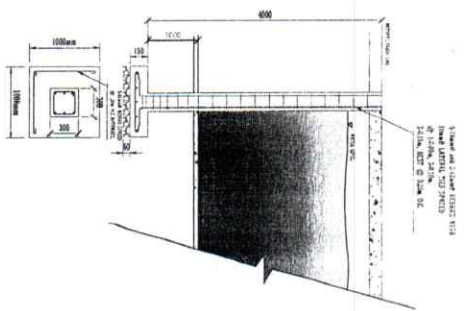

2 CI/CF2 & FOUNDATION PLAN
SCALE 1:30

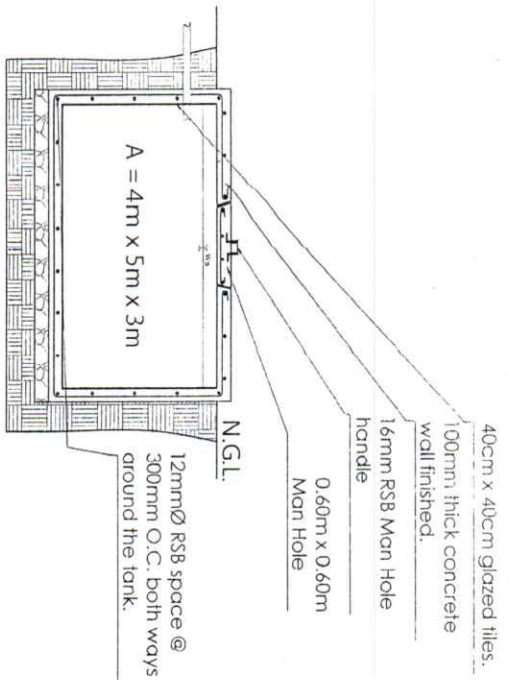

3 WATER BASE TANK DETAILS
SCALE 1:25

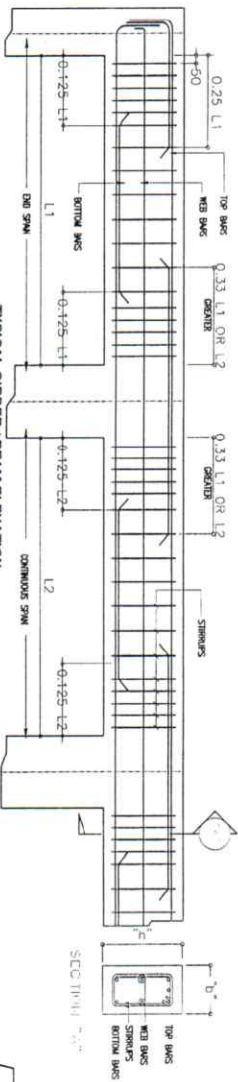

R. C. GIRDER/BEAM SCHEDULE

MARK	SIZE (mm)	REINFORCEMENTS				SPACING
		TOP	BOTTOM	TOP	BOTTOM	
B-1	200x250	3-#16	3-#16	3-#16	3-#16	100, 110/100, R250/150
B-2	200x300	3-#16	3-#16	3-#16	3-#16	100, 110/100, R250/150
RB	250x400	3-#16	3-#16	3-#16	3-#16	100, 110/100, R250/150

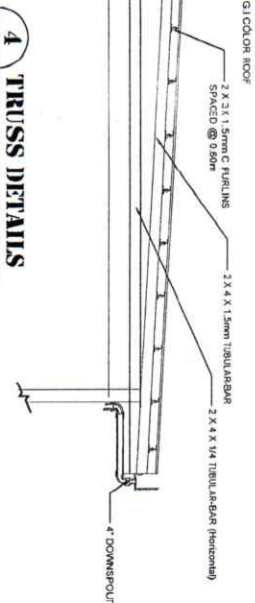

4 TRUSS DETAILS
SCALE 1:100

PREPARED BY: ROMBION STATE UNIVERSITY	CHECKED BY: JEFFREY S. BROWN	PROJECT TITLE: REHABILITATION AND FURNISHING OF OLD/EXISTING UNIVERSITY LIBRARY	SCALE CONTENT: AS SHOWN	PREPARED BY: CAD OPERATOR:
OFFICE OF PHYSICAL PLANT AND FACILITIES	APPROVED BY:	LOCATION: ROMBION STATE UNIVERSITY - Main Campus, Lembang, Otaruga, Romblon	DATE:	DATE:
	PROJ. REG. NO.:		JOB NO.:	P-7
	PROJ. NO.:			